

THE UNIVERSITY OF SOUTH ALABAMA
COLLEGE OF ENGINEERING

OBSERVATIONS OF WAVE SETUP AND TRANSMISSION BEHIND LOW-
CRESTED ARTIFICIAL REEF BREAKWATERS

BY

Kari P. Servold

A Thesis

Submitted to the Graduate Faculty of the
University of South Alabama
in partial fulfillment of the
requirements for the degree of

Master of Science

in

Civil Engineering

December 2015

Approved:

Date:

Chair of Thesis Committee: Dr. Bret M. Webb

Committee Member: Dr. Scott L. Douglass

Committee Member: Dr. Donald A. Beebe

Chair of Department: Dr. Kevin D. White

Director of Graduate Studies: Dr. Thomas G. Thomas

Dean of the Graduate School: Dr. B. Keith Harrison

OBSERVATIONS OF WAVE SETUP AND TRANSMISSION BEHIND LOW-
CRESTED ARTIFICIAL REEF BREAKWATERS

A Thesis

Submitted to the Graduate Faculty of the
University of South Alabama
in partial fulfillment of the
requirements for the degree of

Master of Science

in

Civil Engineering

by

Kari P. Servold

B. S., The University of Alabama, 2012

December 2015

ACKNOWLEDGMENTS

Thank you, Lord, for the strengths, abilities, opportunities, friends, and family you have given me. I am truly blessed to be able to chase my dreams. I cannot thank my family and friends enough for their encouragement and support, especially the love I have received from Gary, Jane, Sara, Patrick, Mitchell, Jena, Richard, Nancy, Mary, Drake, Gracie, Kavu, and Carson. For others not listed here, I wholeheartedly love and thank you.

I would like to sincerely thank my graduate research advisors, Dr. Webb and Dr. Douglass, for their support, guidance, patience, and confidence in me throughout this study and my educational career at the University of South Alabama. I have grown immensely because of your mentorship, and I hope to continue learning from you throughout my professional career. I would also like to thank Dr. Beebe for serving as a member on my thesis committee and for his interest in this study.

This research was made possible through support provided by the U.S. Department of Commerce through the National Oceanic and Atmospheric Administration through The University of Southern Mississippi under terms of Agreement No. **NA10OAR4170078**. The opinions expressed herein are those of the authors and do not necessarily reflect the views of the U.S. Department of Commerce, the National Oceanic and Atmospheric Administration or The University of Southern Mississippi.

TABLE OF CONTENTS

	Page
LIST OF TABLES	v
LIST OF FIGURES	vi
LIST OF SYMBOLS	ix
ABSTRACT	xi
INTRODUCTION	1
LITERATURE REVIEW	6
OBJECTIVE	14
LABORATORY METHODOLOGY	16
LABORATORY RESULTS	23
LABORATORY DISCUSSION.....	29
FIELD OBSERVATIONS.....	33
FIELD METHODOLOGY	36
FIELD RESULTS	44
FIELD DISCUSSION.....	51
CONCLUSIONS.....	55
RECOMMENDATIONS	58
REFERENCES	60
APPENDIX: ADDITIONAL FIGURES	64

BIOGRAPHICAL SKETCH68

LIST OF TABLES

Table	Page
1. Summary of experimental setup for the modeled ReefBLK SM breakwater.....	19
2. Classification of laboratory experiments based on their water depth, d.....	19
3. P-values for the single factor ANOVA laboratory tests	27
4. Water surface elevation data analysis scheme for the Alabama Port living shoreline project site.....	43
5. P-values for the single factor ANOVA field tests	44

LIST OF FIGURES

Figure	Page
1. Elements of a successful living shoreline design.....	4
2. An illustration of standard water level terminology and a definition sketch of wave setup on a shoreline absent of any nearshore structures	7
3. Sketch of possible wave setup driven currents and water fluxes nearshore of a porous, low-crested breakwater field (modeled after Ruol et al., 2004).....	8
4. Cumulative probability distributions of spectrally significant wave height, H_{m0} (Roland and Douglass 2005)	12
5. The University of South Alabama Wave Research Laboratory wave basin setup for conducting the experimental testing of the ReefBLK SM units	17
6. Plan view of the modeled ReefBLK SM breakwater configuration	18
7. Definition sketch of wave and structural parameters used to describe the wave basin scale model testing of a submerged breakwater.....	20
8. The five-minute time-averaged MWL during Test 1.....	23
9. The five-minute time-averaged MWL during Test 2.....	24
10. The five-minute time-averaged MWL during Test 3.....	25
11. The five-minute time-averaged MWL during Test 4.....	26
12. MWL changes, setup and set down, recorded during laboratory tests for each gage location	27

13.	Comparison of recorded changes in the MWL of laboratory tests and the predicted level of setup by Equation 3	28
14.	Alabama Port living shoreline project site located on the western shore of Mobile Bay, Alabama (Image © 2015 Google).....	37
15.	Plan view with definition sketch of the ReefBLK SM breakwater parameters (Figure is not drawn to scale)	38
16.	Cross-sectional view at Transect A (see Figure 9) with definition sketch of the ReefBLK SM breakwater parameters (Figure not drawn to scale)	38
17.	Surveyed beach profiles and placement location of pressure sensors at Alabama Port (Image © 2015 Google)	41
18.	The wave energy record for Sensor 3 at Alabama Port, Alabama during May 2015.....	42
19.	Recorded water level time series data at sensor locations during May 2015	45
20.	Difference in water surface elevation during May 2015 from inside and outside (Sensor 1 – Sensor 3) the monitored reef breakwater segment	46
21.	Transect survey data for Profile 1, Alabama Port, Alabama	47
22.	Transect survey data for Profile 2, Alabama Port, Alabama	48
23.	May 2015 transmission coefficients, K_t , of the monitored ReefBLK SM breakwater segment at Alabama Port, Alabama.....	49
24.	Significant wave height frequency of occurrence (less than) observed during the May 2015 monitoring study compared to the frequency of significant wave height occurrence (less than) developed for Alabama Port, AL by Roland and Douglass (2005).....	50
Appendix		
	Figure	Page
A1.	Plan View of a model ReefBLK SM unit with dimensions (Not drawn to scale) (Allen 2013).....	64
A2.	Historical aerial imagery of the shoreline at Alabama Port,	

Alabama in May 2015 (Image © 2015 Digital Globe).....	65
A3. Erosional marsh shoreline (looking north) leeward of northern ReefBLK SM breakwater segment at Alabama Port, Alabama	66
A4. Mounts developed to hold sensors at deployment locations.....	67

LIST OF SYMBOLS

SWL	=	Still water level
MWL	=	Mean water level
MSL	=	Mean sea level (considered the same as MWL)
η	=	Instantaneous free surface of the water
$\bar{\eta}$	=	Wave setup or set down, Δ MWL
H_i	=	Incident wave height
H_t	=	Transmitted wave height
K_t	=	Transmission coefficient, (H_t / H_i)
H_{re}	=	Reflected wave height
H_I	=	Sum of the squares of the incident and reflected wave heights, ($H_i^2 + H_{re}^2$)
k	=	Wave number ($2\pi/L$)
d	=	Water depth
R_c	=	Breakwater freeboard, ($h_c - d$)
EXP	=	Base of natural logarithms
H_{mo}	=	Spectrally significant wave height
h_c	=	Breakwater structure height
B_c	=	Breakwater crest width
T	=	Wave period

α	=	Confidence interval for ANOVA tests
H_o	=	Null hypothesis for Laboratory Tests ($H_o : \overline{\eta_{Gage\ 1}} = \overline{\eta_{Gage\ 2}} = \overline{\eta_{Gage\ 3}} = \overline{\eta_{Gage\ 4}}$) Field Tests ($H_o : \overline{\eta_{Sensor\ 1}} = \overline{\eta_{Sensor\ 2}} = \overline{\eta_{Sensor\ 3}} = \overline{\eta_{Sensor\ 4}}$)
L	=	Wave length
L_s	=	Length of breakwater structure
X	=	Distance of breakwater from original shoreline
L_g	=	Gap distance between adjacent breakwaters
H_{avg}	=	Average of all observed wave heights
T_{avg}	=	Average of all observed wave periods
E	=	Wave energy (J/m^2)

ABSTRACT

Servold, Kari, P., M. S., University of South Alabama, December 2015. Observations of Wave Setup and Transmission behind Low-Crested Artificial Reef Breakwaters. Chair of Committee: Dr. Bret M. Webb.

This study combines field and laboratory investigations to qualitatively examine wave setup induced water ponding/ piling-up behind a low-crested engineered oyster reef breakwater structure. Results from laboratory tests of reduced scale breakwater models indicate the facilitation of wave setup (set down) of the mean water level at locations leeward (incident) of the breakwater segment. Laboratory results of wave setup were compared to a predictive equation given in the published literature, but a meaningful agreement was not found. Field monitoring of a prototype breakwater segment located near Alabama Port, Alabama in May 2015 did not reveal significant changes in the mean water levels near the breakwater prototype location. The typical wave climate observed during the monitoring period consisted of short-crested wave heights of less than 0.1 m with wave transmission rates as high as 78% of the incident wave height. Collectively, the mild wave climate and the poor wave attenuation capabilities of the low-crested breakwater likely prevented the development of wave setup during the monitoring period. It is recommended that further studies continue to investigate hydrodynamic interactions related to low-crested oyster reef breakwater structures used in living shoreline stabilization projects, particularly during storm events or more energetic conditions.

INTRODUCTION

Chronic coastal erosion is a major threat to coastal resources and communities along estuarine shorelines in the United States. Coastal erosion and recession are natural environmental responses of shorelines to effects from rising sea levels, hydrodynamic interactions, and their subsequent impact on storms, tides, waves, currents, and littoral sediment transport. Although coastal erosion and recession develop naturally from these events and interactions, land management practices, coastal development, and interventions within the natural coastal ecosystem continue to raise the burden they have on the remaining undeveloped shorelines of urbanizing watersheds.

Hard coastal-protection structures are commonly used solutions to manage and control shoreline changes from the influence of chronic coastal erosion. Some of the most commonly applied coastal protection structures for hard armoring along sheltered shorelines include seawalls, bulkheads, and revetments. These hard shoreline armoring techniques primarily provide upland property protection, which make them highly sought erosion control solutions by coastal property owners. Scyphers et al. (2015) describe the trends among Mobile Bay, Alabama waterfront property owners seeking shoreline armoring solutions, and show that such actions are instigated by damages and losses associated with adjacent armored shorelines. This agrees with the findings of Douglass

and Pickel (1999) who show that increasing rates of shoreline armoring on Mobile Bay, Alabama from 1955 to 2007 positively correlated to population increase.

Hard shoreline armoring is known to contribute to habitat loss and degradation of natural shorelines (Scyphers et al. 2015). Hard shoreline armoring contributes to the erosional pressures affecting neighboring undeveloped shorelines by limiting the addition of sediment and facilitating wave reflections. This additional increase in erosional pressure resulting from the increased presence of coastal armoring has negative cumulative effects. A recent study in Mobile Bay indicates that approximately 92.7% of the bay's unarmored shorelines show distinctive erosional trends over the period 1996 to 2008 (Jones et al. 2009). As natural shorelines, wetlands, and intertidal habitat continue to degrade in response to the effects from hard armoring and natural erosional pressures, their ability to provide valuable ecosystem services also deteriorates; ecosystem services provided by coastal habitats are addressed in published literature, and include such things as habitat for species, storm surge buffers, and storage for sediment and pollutants.

Because many bay and estuarine shorelines around the nation face seemingly similar issues of habitat loss and shoreline erosion and recession, there is a growing popularity surrounding the potential use of alternative stabilization techniques. Shoreline stabilization designs that focus on protecting and maintaining natural shoreline ecosystems and functions are known as "living shorelines". The National Oceanic and Atmospheric Administration (NOAA 2013a) defines living shorelines as:

"A shoreline management practice that provides erosion control benefits; protects, restores, or enhances natural shoreline habitat; and maintains coastal processes through the strategic placement of plants, stone, sand fill, and other structural organic materials (e.g. biologs, oyster reefs, etc)."

In living shoreline designs low-crested, environmentally friendly, reef breakwater structures serve dual purposes of attenuating wave energy and providing habitat value (oysters, fish, etc.) that exceeds that of armored shorelines (Douglass et al. 2012; Hardaway and Byrne 1999). The local wave and sediment transport climate often dictate when structural elements, such as low-crested breakwaters, are necessary to include as part of a living shoreline design.

Low-crested breakwaters are shore-parallel structures that are frequently submerged by the mean water level (MWL) or regularly overtopped by waves (Burcharth et al. 2007). Successfully incorporating low-crested reef breakwater technology into living shoreline designs is challenging and requires understanding the minimum amount of structural design necessary to address the unique needs and issues affecting a particular shoreline. However, there is limited scientific understanding of the performance and function provided by low-crested oyster reef breakwaters, which are dissimilar from traditional rubble-mound structures (Allen 2013). Additionally, all shorelines are not identical; what may be present, not present, or an issue at one shoreline may or may not be present or an issue at another. This makes living shorelines difficult to design because a “one size fits all” approach is not applicable. Achieving an adequate and successful living shoreline stabilization design, therefore, requires a uniquely calculated combination of components from coastal ecology, coastal hydrodynamics, and coastal engineering (see Figure 1).

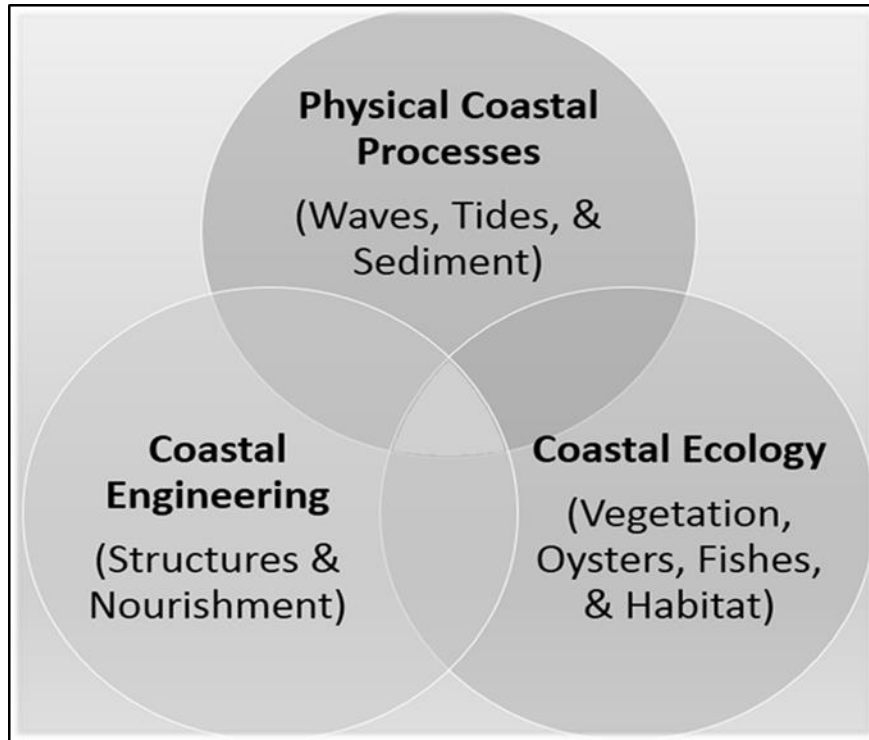

Figure 1. Elements of a successful living shoreline design.

Recently, many investigators have referenced uncertainties surrounding the functional design and predictability of hydrodynamic interactions of low-crested breakwaters, which are frequently used in living shoreline stabilization projects (Burcharth et al. 2007; Lamberti et al. 2005; Scyphers et al. 2014). Uncertainties surrounding newly emerging low-crested and submerged reef breakwater technologies include scientific knowledge on wave attenuation capabilities, predictable shoreline responses, structural interference of sediment supply and transport processes, and alterations of local hydrodynamics (currents, water levels, etc.). Low-crested breakwaters modify the local hydrodynamics through the facilitation of wave transmission, reflection, overtopping, diffraction, and other wave-structure interactions.

Collectively these wave-structure interactions have the potential to supply a transfer of mass and momentum in, over, and around porous, low-crested, oyster reef breakwater structures. This drives temporary fluxes in the water column that lead to localized water retention and current generation, and in some cases shoreline erosion. This phenomena is known as wave setup or piling-up in literature sources (Diskin et al. 1970; Loveless and MacLeod 1999), and is the focus of this research investigation.

LITERATURE REVIEW

As waves propagate toward the shoreline, decreasing water depths induce wave breaking and decay across the surf zone, dissipating the energy of the breaking waves (Sorensen 2006). Wave momentum, however, is conserved upon wave breaking, which results in a transfer of wave related momentum to the water column (Dean and Walton 2009). The momentum flux created from the reduction in wave energy drives the displacement of the mean water level, proportional to the bottom slope, which increases linearly from the breaker line as the shoreline is approached (Dalrymple and Dean 1991; USACE 1984). This phenomena is known as wave setup or piling-up, and occurs on all shorelines with active wave breaking.

Figure 2 defines standard water level terminology and gives a definition sketch for wave setup in the surf zone for a shoreline absent of any nearshore structures. The still water level (SWL) is the water level elevation in the absence of wave effects. The free surface of the water, η , is an instantaneous value of the water surface elevation. The mean water level (MWL) is the time-averaged water surface elevation. Wave setup, $\overline{\eta}$, is the increase in the time-averaged MWL inside the surf zone above the SWL due to the transfer of wave-related momentum to the water column during wave breaking. Likewise, $\overline{\eta}$, can also indicate a decrease or lowering in the time-averaged MWL; the latter case is referred to as wave set down.

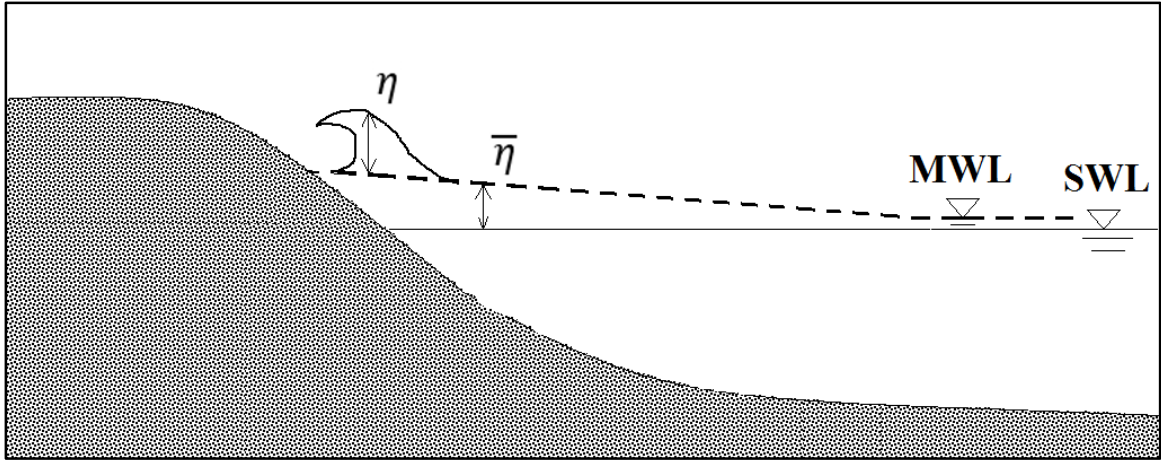

Figure 2. An illustration of standard water level terminology and a definition sketch of wave setup on a shoreline absent of any nearshore structures.

When a structure, such as a low-crested reef breakwater, is located near the shoreline an additional contribution to wave setup can develop, which is similar to the phenomena of water setup shoreward of natural reefs (Douglass and Weggel 1987). As waves break over and across a submerged structure an additional mass contribution is added to the water column. The overtopping of water entering the region behind the structure accumulates and under some circumstances establishes a mean hydraulic head that drives nearshore currents and return flows. Breakwater geometries, structural placement nearshore, and local MWL and wave climate collectively interact with one another to promote currents and return flows whose response pathways are restricted to pathways of flow over, through, or around the structure (see Figure 3).

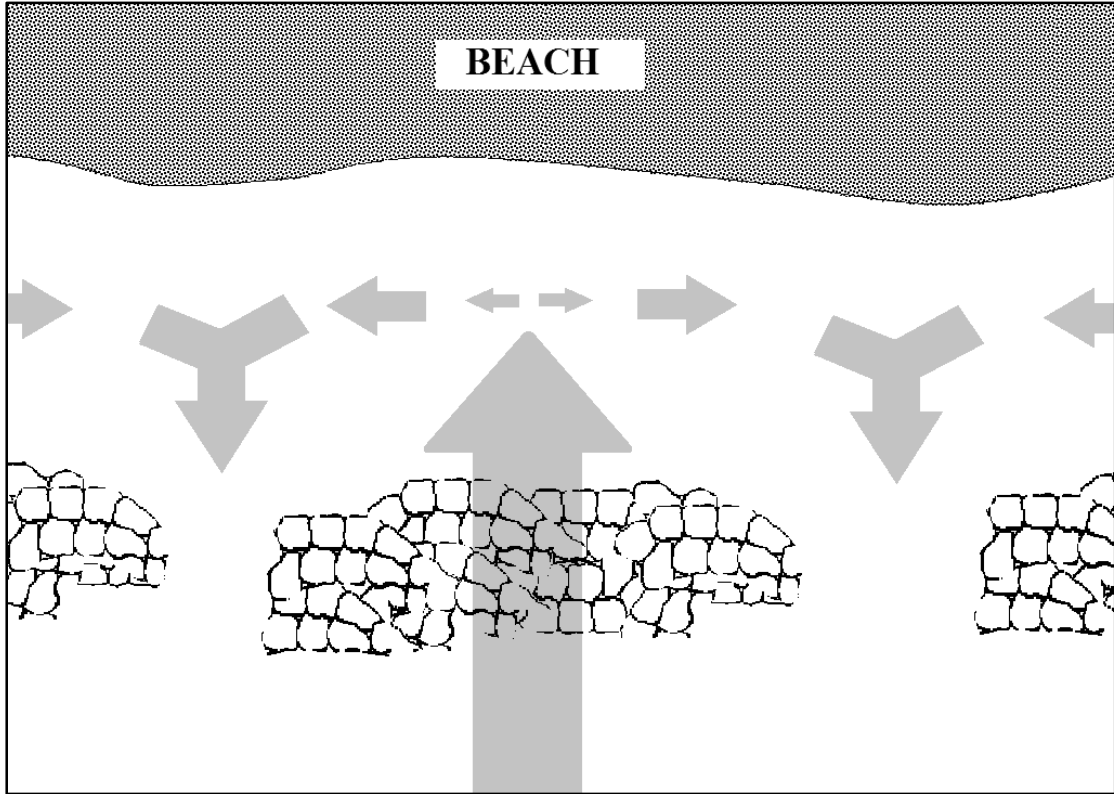

Figure 3. Sketch of possible wave setup driven currents and water fluxes nearshore of a porous, low-crested breakwater field (modeled after Ruol et al. 2004).

The generation of wave setup and related current effects behind low-crested engineered reef breakwaters are known to reduce the intended positive effect of beach protection attributable to wave height reduction, also referred to as wave attenuation (Ruol and Faedo 2002). The wave transmission coefficient, K_t , describes wave attenuation as the ratio of the transmitted wave height, H_t , to the incident wave height, H_i , given mathematically in Equation 1 (USACE 1984).

$$K_t = \frac{H_t}{H_i} \quad (\text{Eq. 1})$$

It is common engineering practice to design and evaluate the performance of breakwaters based on their ability to provide wave energy reduction, where energy is proportional to the square of the wave height. However, numerous researchers indicate that altered nearshore hydrodynamic changes stemming from wave-structure interactions of low-crested and submerged breakwater designs contribute to shoreline erosion (Cappiotti et al. 2012; Dean et al. 1997; Stauble et al. 2000). Ruol et al. (2004) mention that the use of low-crested breakwater structures in shoreline stabilization and shoreline protection projects often lead to unexpected erosion of the leeward shorelines. The authors relate this failure to the complexity surrounding the structural tradeoffs of low-crested breakwater designs to reduce wave energy by attenuating wave heights and inducing wave setup from altered hydrodynamics.

Longuet-Higgins (1967) proposes an analytical solution for the case of a submerged impermeable breakwater where no wave breaking is considered that directly solves for wave setup, $\bar{\eta}$, and is given mathematically in Equation 2,

$$\bar{\eta} = \frac{H_1^2 k_1}{8 \sinh(2k_1 d_1)} - \frac{H_t^2 k_2}{8 \sinh(2k_2 d_2)} \quad (\text{Eq. 2})$$

where H_1 is the sum of the squares of the incident and reflected wave heights, H_i and H_r respectively; H_t is the transmitted wave height; k is the wave number ($k = 2\pi/L$); d is the water depth; and the numerical subscripts indicate parameter values for locations before, 1, and behind, 2, the breakwater. However, when wave breaking occurs, which is

dissimilar from the assumptions used to develop Equation 2, it is noted that total setup must account for both momentum and mass fluxes (Dalrymple and Dean 1971).

Diskin et al. (1970) offers an empirical relationship for wave setup, $\bar{\eta}$. Based on laboratory tests of low-crested and submerged permeable trapezoidal breakwaters, Diskin et al. (1970) formulated a Gaussian-type equation given mathematically by Equation 3 (Calabrese et al. 2003),

$$\bar{\eta} = H_i \cdot 0.60 \cdot \text{EXP}\left[-\left(0.70 - \frac{R_c}{H_i}\right)^2\right] \quad (\text{Eq. 3})$$

where H_i is the incident wave height; EXP is the base of natural logarithms; and R_c is breakwater freeboard ($R_c = h_c - d$), where h_c is the height of the structure crest relative to the sea bottom. Again, Dalrymple and Dean (1971) suggest that total setup measured leeward of the breakwaters studied by Diskin et al. (1970) is really a component of the same wave setup that occurs naturally on sloping beaches with active wave breaking (see Figure 2), and a contribution due to the mass of water overtopping the structure (see Figure 3). Additionally, Burcharth et al. (2007) suggest that wave setup is controlled by the hydraulic behavior of the mass flux contribution when the crest of the breakwater structures are overtopped but not submerged by water. Likewise, the momentum flux contribution is the major contributor to wave setup when waves actively break over a submerged structure (Calabrese et al. 2003).

Shoaling, diffraction, refraction, transmission, and reflection of waves as they approach the shoreline and interact with low-crested breakwaters induces a suite of

nearshore hydrodynamic changes. In particular, the development of wave setup is a concern for living shoreline designs for many reasons, but is not specifically identified in published literature. Low-crested living shoreline breakwater designs must ensure that wave energy reaching the shoreline is tolerable for establishment and survival of shoreline species. Roland and Douglass (2005) investigates the wave energy tolerance of *Spartina alterniflora* locally in Alabama (Roland and Douglass 2005), but wave energy tolerance is not quantitatively known for other fringe marsh species and tidal regions (Shafer, Roland, and Douglass 2003). Thirteen years of wind-wave hindcast data from Roland and Douglass (2005) suggest that for non-eroding salt marsh shorelines on Mobile Bay the median spectrally significant wave height, H_{mo} , is about 0.1 m (0.33 ft) (see Figure 4).

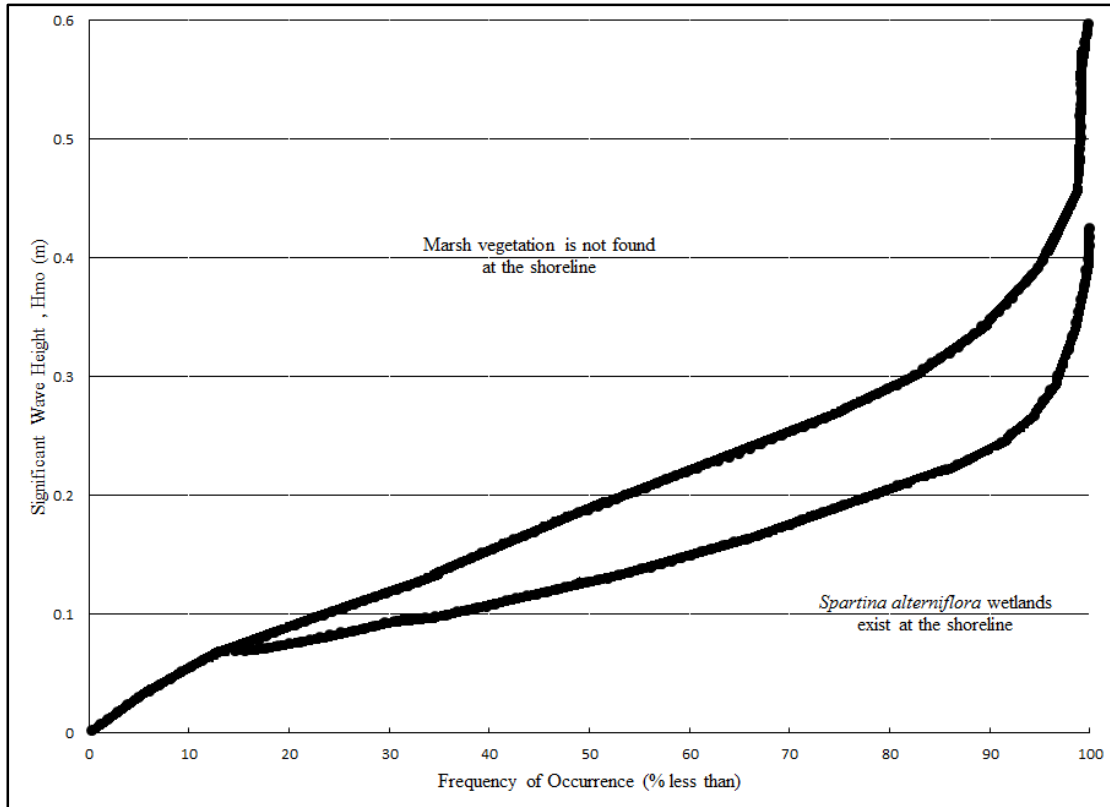

Figure 4. Cumulative probability distributions of spectrally significant wave height, H_{mo} (Roland and Douglass 2005). The top curve represents the transition from sandy shorelines to occurrences of sandy and vegetative shorelines. The bottom curve represents the transition from sandy and vegetative shoreline occurrences to only vegetative shorelines.

Additionally, increases in mean sea level (MSL) and nearshore current generation by submerged and low-crested breakwater structures effect the survivability of coastal wetland vegetation and sediment retention. Low-crested reef breakwaters must ensure sediment retention requirements of the living shoreline project because momentum fluxes in the cross-shore direction have the potential to develop nearshore currents that remove and transport sediment offshore and along the coast. Sediment transport interactions are

important to consider since shoreline elevation and gradation are critically sensitive characteristics controlling regions of coastal wetland species establishment (Stout 1990).

The elevation of the marsh vegetation relative to MSL is also a critical factor controlling and maintaining marsh productivity and marsh equilibrium with rising sea levels (Morris et al. 2002). NOAA (2013b) reports that the average seasonal MSL trends at Dauphin Island, Alabama are on the order of 25 cm. According to Morris et al. (2002), “Interannual changes in MSL on the order of 5-10 cm have a great effect on primary productivity of *Spartina alterniflora*.” If increased water levels and current generation occur frequently enough the subsequent effect is a routine increase in MSL and a corresponding adjustment of the marsh or sandy foreshore.

Ruol et al. (2004) mention that wave setup is not a thoroughly investigated subject matter in terms of a noteworthy relationship to breakwater designs being implemented within shoreline stabilization projects. Effects of wave setup from low-crested and submerged permeable breakwater structures are theoretically investigated for open ocean shorelines (Dean et al. 1997), natural reefs (Tait 1972), and documented through numerous laboratory and flume test experimentations (Diskin et al. 1970). However, only one documented field study in the existing literature directly quantifies wave setup occurring behind a breakwater (Cappiotti et al. 2012). This demonstrates that there is a need for further investigations into low-crested and submerged permeable breakwaters. Specifically, there is a need to investigate and discuss wave setup effects behind low-crested oyster reef breakwaters implemented in living shoreline stabilization projects on sheltered bay and estuarine shorelines.

OBJECTIVE

The focus of this research investigation is on the development of nearshore hydrodynamic changes that result in the setup of water leeward of low-crested oyster reef breakwaters, which has received little attention particularly in the design of living shoreline projects. The motivation behind this investigation is from a living shoreline project site located at Alabama Port, Alabama, which uses low-crested oyster reef breakwaters to provide habitat enhancement and wave energy modification to afford protection to the leeward marsh shoreline. It is suggested that structure-induced wave setup produced during strong southeasterly winds is causing frequent increases in the MWL, leading to the continued degradation and destruction of the leeward shoreline and marsh habitat.

To investigate and qualify the hydrodynamic alteration capabilities of low-crested oyster reef breakwaters, scale model testing of a modeled ReefBLKSM breakwater segment was conducted at the University of South Alabama's Wave Research Laboratory. Additionally, the wave setup capabilities of a prototype ReefBLKSM breakwater segment were examined through a month-long field deployment in May 2015. Discussed herein are the monitored wave characteristics and changes in MWL (setup/setdown) observed from the laboratory and field experiments, which seek to discover the unique hydrodynamic interactions that are limiting the success of living shoreline

projects which use low-crested oyster reef breakwater technologies. This is the first known study that combines both field and laboratory investigations to examine the facilitation of wave setup and unfavorable hydrodynamics associated with low-crested oyster reef breakwaters used in living shoreline projects on estuarine shorelines.

LABORATORY METHODOLOGY

The laboratory tests in this study are 1:2 (model: prototype) geometric scale models of the ReefBLKSM breakwater units developed by Coastal Environments, Inc. The ReefBLKSM model units were fabricated by Richard Allen with the assistance of John Lyon for a previous university study, Allen (2013). The model units have side lengths of 0.76 m (30 in), a structure height, h_c , of 0.30 m (12 in), and a core substrate width of 0.07 m (2.88 in). Appendix Figure A1 provides a plan view of the dimensions of a model ReefBLKSM unit developed by Allen (2013).

The core of the model ReefBLKSM units uses shells of juvenile eastern oysters, *Crassostrea virginica*, which are a reduced oyster shell substrate from the size used in prototype designs, but does not adhere to a specific scale as noted in Allen (2013). However, the juvenile shells are approximately one-half the size of mature shells. The netting material which houses the juvenile eastern oyster shell substrate is a 13 mm (0.51 in) mesh characterized as a “Rigid Polyethylene Diamond Shape Netting” (Allen 2013). Allen (2013) presents more detailed information regarding the model design and fabrication of the scaled ReefBLKSM units used in this laboratory study.

Eight modeled ReefBLKSM units were alternately placed and anchored across the width of the University of South Alabama’s Wave Research Laboratory wave basin to form a continuous breakwater segment. The wave basin is 6.09 m (20 ft) wide and 9.14

m (30 ft) long (see Figure 5). Return gaps of less than 0.15 m (0.5 ft) exist between the ends of the anchored breakwater segment and the wave basin side walls to facilitate the return flow of water around the ends of the modeled ReefBLKSM breakwater segment. The modeled ReefBLKSM breakwater crest width, B_C , is defined as the crest width measured perpendicularly from a point closest to the incident wave direction on one unit to the point farthest from the incident wave direction of an adjacent unit (see Figure 6).



Figure 5. The University of South Alabama Wave Research Laboratory wave basin setup for conducting the experimental testing of the ReefBLKSM units.

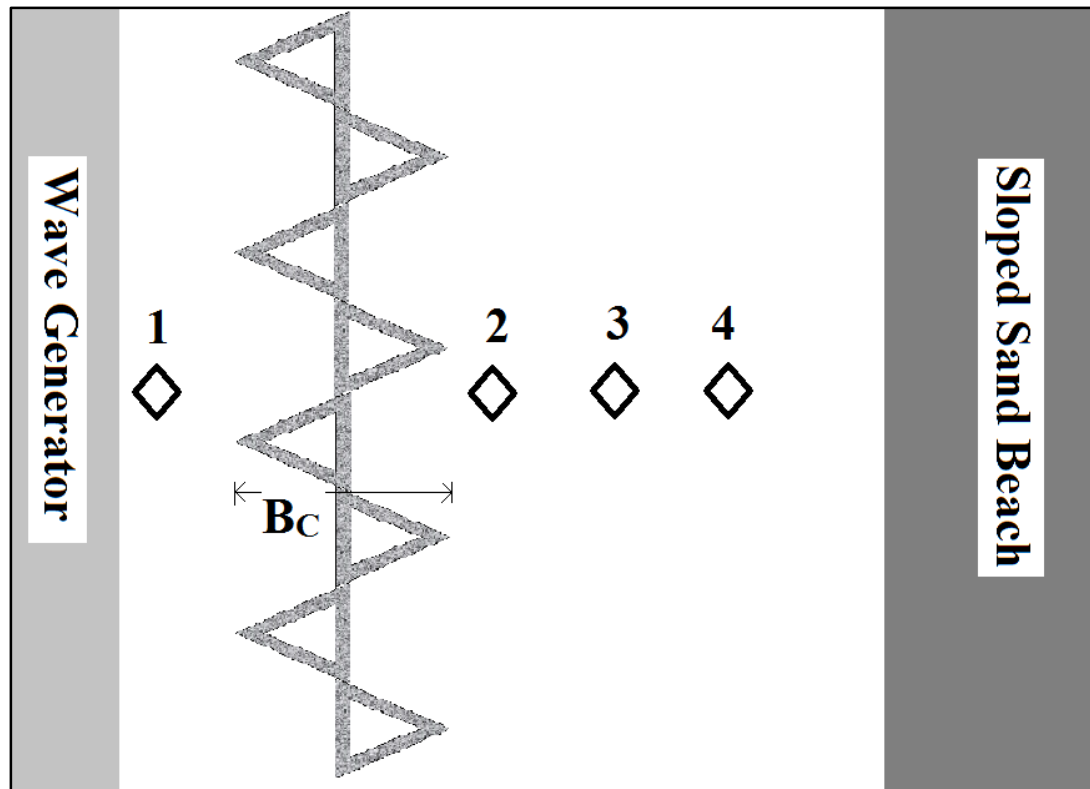

Figure 6. Plan view of the modeled ReefBLKSM breakwater configuration. The crest width measurement and gage placement locations for the ReefBLKSM testing are defined.

Table 1 provides a summary outlining the experimental setup of the laboratory tests conducted in this study. A monochromatic model wave, with a wave height of 0.21 m (8.30 in) and a wave period of 2.43 s, was simulated and run without interruption for approximately twenty minutes for each laboratory experiment. Additionally, adequate time was allotted between experiments to drain the basin to a lower water level and to allow the water surface to still from previous tests. Although the same wave file was selected for all laboratory experiments, variations in tested water depths resulted in changes of the simulated wave height and wave period.

Table 1. Summary of experimental setup for the modeled ReefBLKSM breakwater.

Experimental Setup	
Configuration	Alternating Point
Water Depths, d	0.337, 0.318, 0.248, 0.213 m
Wave Height, H	0.21 m
Wave Period, T	2.43 s
Structure Height, h_c	0.30 m
Total Experiments	4

Four water depths, d, were tested to determine if significant changes in the mean water surface elevation, wave setup or set down, $\Delta \bar{\eta}$, occurred at locations incident and leeward of the scale model ReefBLKSM breakwater. Laboratory experiments were classified based on their tested water depth (see Table 2).

Table 2. Classification of laboratory experiments based on their water depth, d.

Experimental Test	Water depth, d (m)
Test 1	0.337
Test 2	0.318
Test 3	0.248
Test 4	0.213

Testing performed at water depths, d, of 0.337 m (13.25 in) and 0.318 m (12.5 in), Tests 1 and 2 respectively, examined the development of setup and set down under submerged conditions, or negative freeboard, - R_c. This means that the crest of the breakwater, h_c, was submerged or below the SWL during testing. Figure 7 provides a definition sketch of submerged breakwater conditions, which illustrate the structural geometries and wave-water parameters important to the scale model testing. Emergent breakwater tests, Test 3 and Test 4, at water depths of 0.248 m (9.75 in) and 0.213 m

(8.375 in) respectively, correspond to tests where the breakwater crest height was higher than the SWL ($h_c > d$), or positive freeboard, $+R_c$.

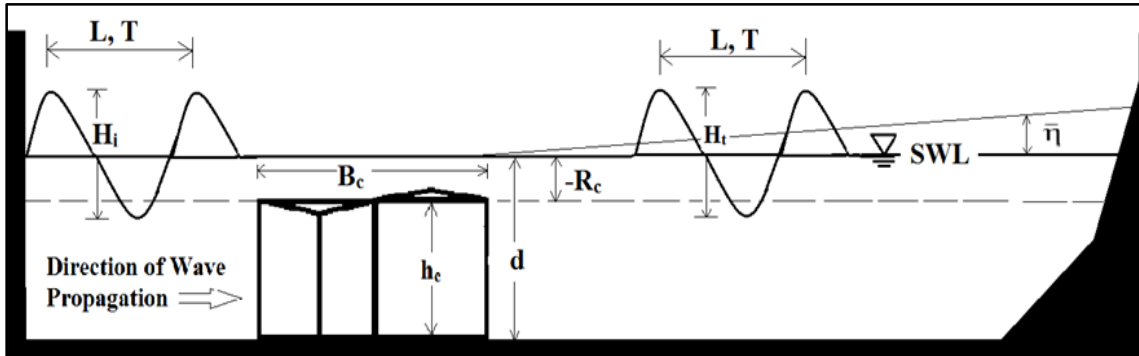

Figure 7. Definition sketch of wave and structural parameters used to describe the wave basin scale model testing of a submerged breakwater.

Four, two-wire capacitance wave gages were used during laboratory testing to record instantaneous water surface elevations, η , at each gage location. The capacitance gages were centered along the still water surface so that a comparison between recorded water surface elevations at the gage locations could be conducted. Gages were placed perpendicularly down the centerline of the modeled ReefBLKSM breakwater (see Figure 5). The arrangement of the four capacitance gages was such that water surface elevations incident to the structure and water surface elevations in the transmitted region were recorded. Gage 1 was placed between the wave generator and the modeled ReefBLKSM breakwater segment, and Gage 2, Gage 3, and Gage 4 were placed in consecutive order leeward of the model ReefBLKSM breakwater segment (see Figure 5 and Figure 6). A sampling rate of 10 Hz was used for all capacitance gages. Gage data were recorded

using LabView, a program created by the National Instruments, and were exported to Microsoft Excel for analysis.

A single factor analysis of variance (ANOVA) was used to determine if the averages of water surface elevations recorded at each of the four capacitance gage locations were significantly different from one another. A 95% confidence interval ($\alpha = 0.05$) was used for all laboratory ANOVA tests. If the P-value obtained from a single factor ANOVA was greater than the alpha value ($\alpha = 0.05$), then the null hypothesis, H_o , was not rejected. Similarly if the P-value was less than the alpha value ($\alpha = 0.05$), then the null hypothesis was rejected. The null hypothesis, H_o , given by Equation 4, was used to assess laboratory experiments,

$$H_o : \overline{\eta_{\text{Gage 1}}} = \overline{\eta_{\text{Gage 2}}} = \overline{\eta_{\text{Gage 3}}} = \overline{\eta_{\text{Gage 4}}} \quad (\text{Eq. 4})$$

where the average water surface elevations, $\overline{\eta}$, recorded at each gage were considered equal to one another. For example, the MWL at Gage 1 was equal to Gage 2, Gage 3, and Gage 4. Failure to reject the null hypothesis, H_o , indicates that there was no statistically significant setup or set down in the mean water level measured at the gage locations. Rejection of the null hypothesis indicates that there was a significant difference between the means of the water surface elevations recorded at the gage locations. Rejection of the null hypothesis further suggests that there was at least one inequality that existed between the MWL's recorded at the gages, suggesting setup or set down occurred at a minimum of one of the gage locations.

Single factor ANOVAs were performed on the entire data record for each gage from each of the four laboratory tests conducted in this study. The results of the ANOVA tests conducted on the scale model ReefBLKSM breakwater laboratory experiments were assessed using Equation 4. Additionally, setup predictions of the modeled ReefBLKSM breakwater (see Equation 3) were compared to the measured MWL changes to assess the ability of Equation 3 to predict setup for low-crested oyster reef breakwater designs. The results of these investigations are presented and discussed in subsequent sections.

LABORATORY RESULTS

Five-minute time-averaged MWL data for the laboratory experiments conducted in this study are given in Figures 8, 9, 10, and 11 for Tests 1, 2, 3, and 4 respectively.

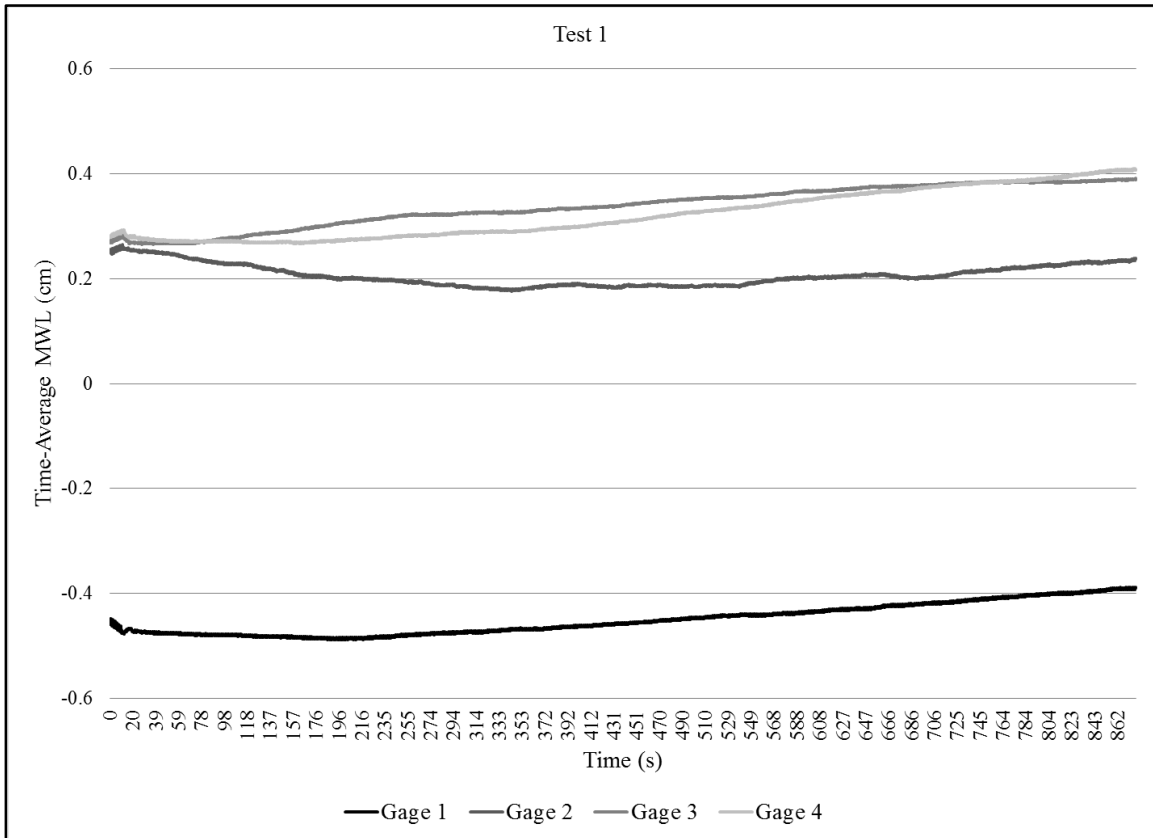

Figure 8. The five-minute time-averaged MWL during Test 1.

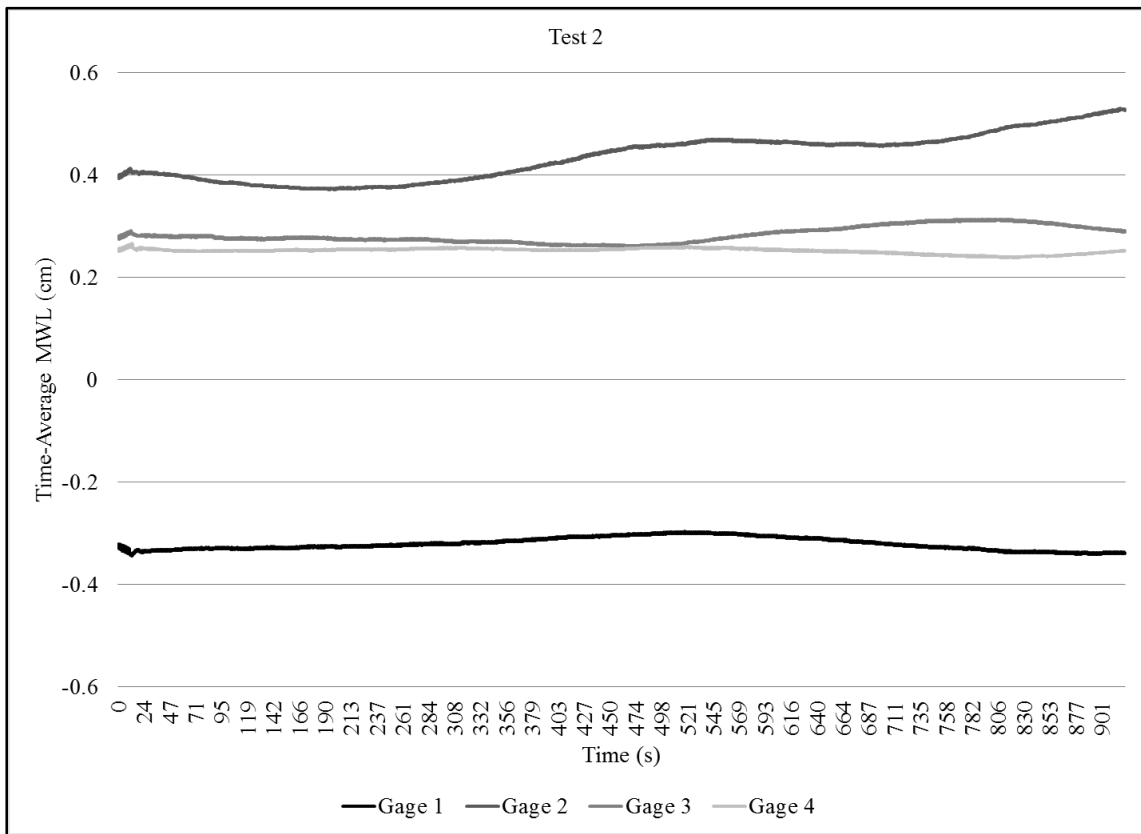

Figure 9. The five-minute time-averaged MWL during Test 2.

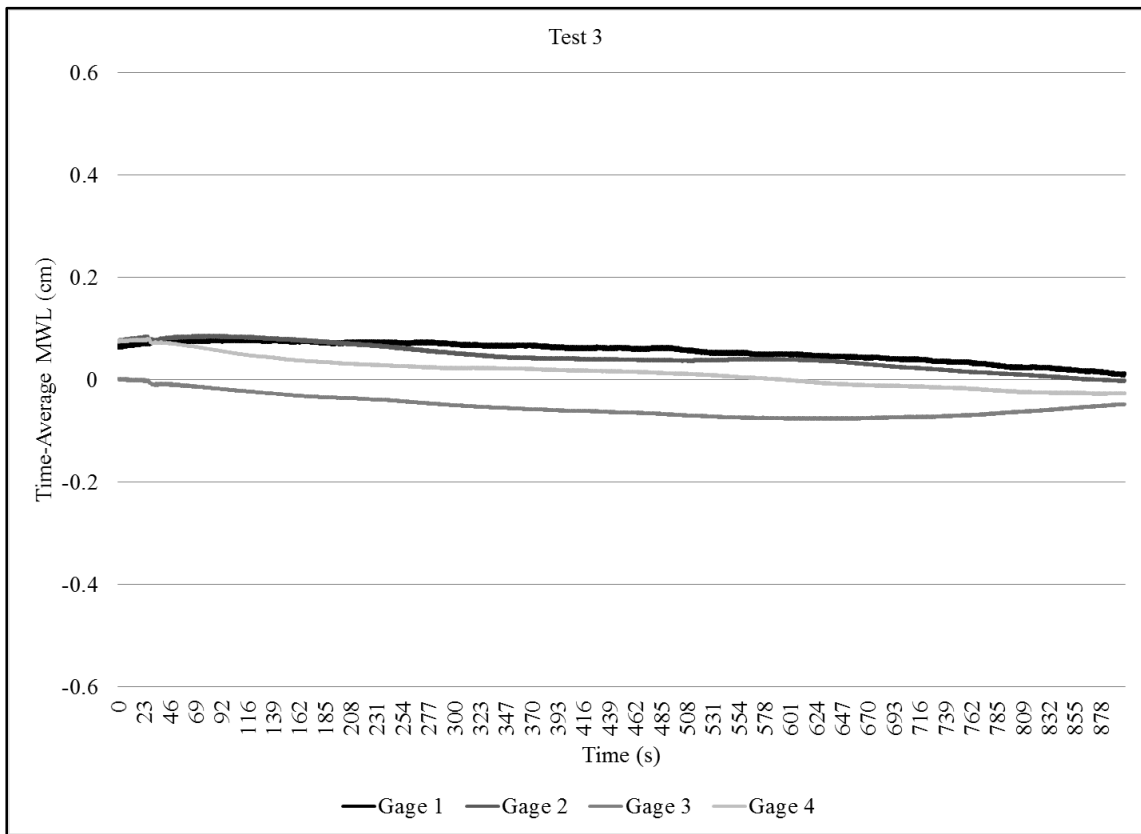

Figure 10. The five-minute time-averaged MWL during Test 3.

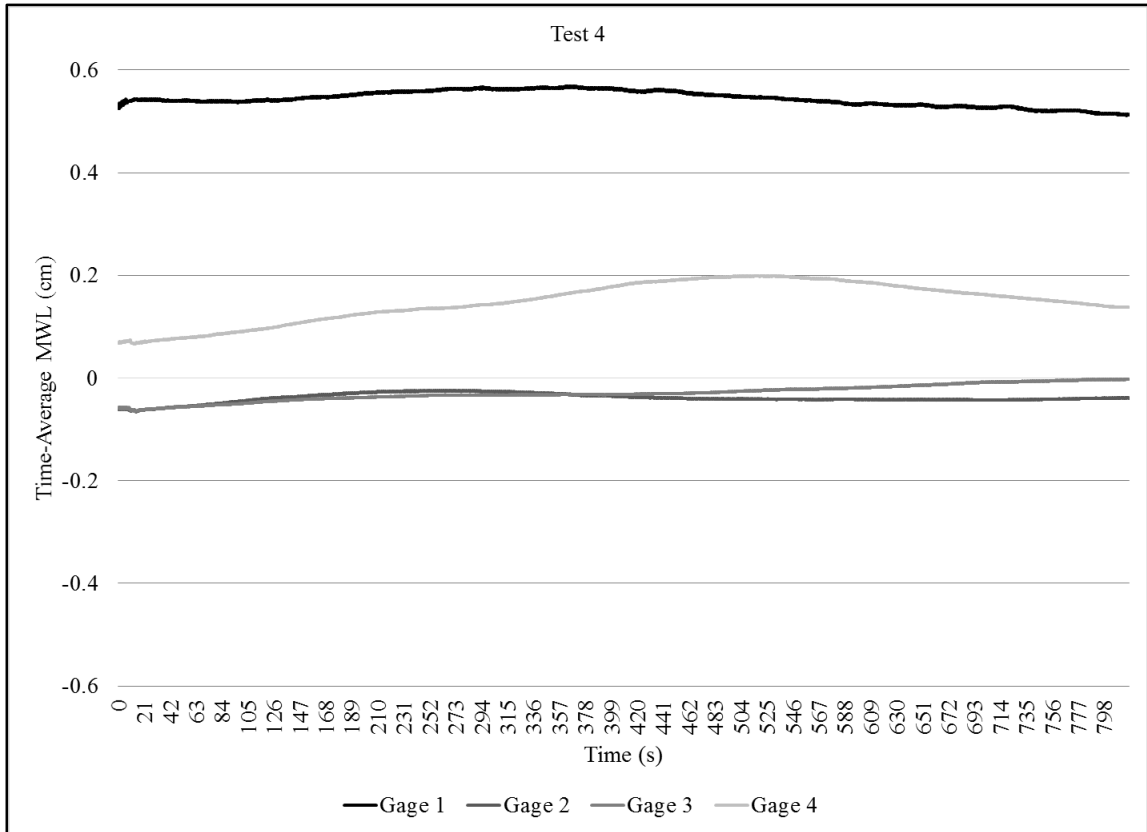

Figure 11. The five-minute time-averaged MWL during Test 4.

The MWLs were further examined through the use of single factor ANOVAs. The single factor ANOVA P-values obtained from the comparison of the average water surface elevation data at each gage location for the four tested water depths are given in Table 3. Figure 12 graphically presents the average water surface elevations, $\bar{\eta}$, recorded at each gage for the four laboratory tests conducted in this study. Figure 13 presents the results of the comparison between estimated setup (Equation 3), and the MWL changes recorded at each of the gage locations during the four laboratory tests conducted in this study.

Table 3. P-values for the single factor ANOVA laboratory tests.

Experimental Test	P-Value	95 % Confidence Interval
Test 1	3.8E-100	0.05
Test 2	1E-103	0.05
Test 3	0.005	0.05
Test 4	5.2E-141	0.05

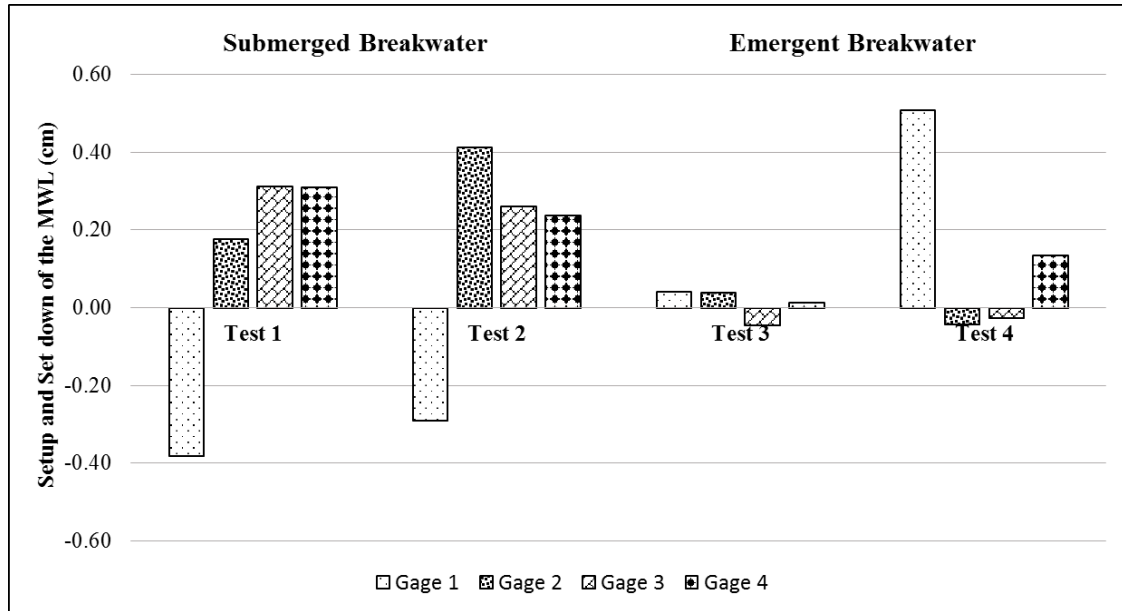

Figure 12. MWL changes, setup and set down, recorded during laboratory tests for each gage location.

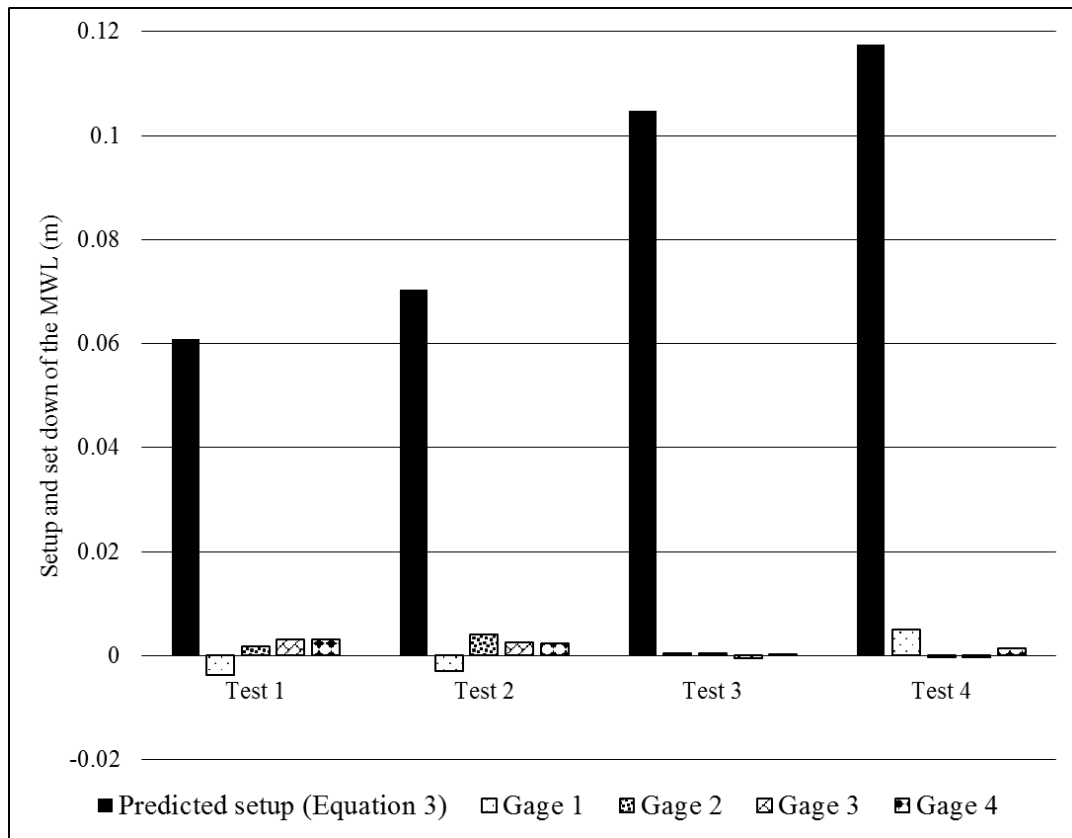

Figure 13. Comparison of recorded changes in the MWL of laboratory tests and the predicted level of setup by Equation 3.

LABORATORY DISCUSSION

Figures 8, 9, 10, and 11 revealed that for each water depth tested there was at least one inequality between the water surface elevations recorded at the four gages. Results presented in Table 3 further suggest that setup or set down in the average water surface elevation occurred at one or more of the four capacitance gage locations (see Equation 4).

During submerged testing conditions the average water surface elevations recorded at Gage 1 indicated that significant set down in the MWL occurred. Further investigation of Test 1 and Test 2 showed that setup in the MWL occurred at Gages 2, 3, and 4 (see Figure 8 and Figure 9). However, during Tests 1 and 2, there were no statistically significant differences between average water surface elevations measured at Gage 3 and Gage 4. In other words, during Test 1 and Test 2, Gage 3 and Gage 4 obtained equivalent increases in MWLs at their placement locations (see Figure 12). Test 1 showed the largest change in MWL at Gage 4 located nearest the sand beach, while Test 2 showed the largest collective increase in MWL of all laboratory tests for the leeward gage locations, Gages 2, 3, and 4.

Test 3 revealed minimal fluctuations of the water surface elevations (see Figure 10). However, ANOVA results suggested that statistically significant setup and set down changes in the MWL were observed, but at reduced magnitudes compared to other laboratory tests. Additionally, setup at Gage 1 and Gage 2 during Test 3 were found to

be of equal magnitude. Test 3 also revealed that there was statistically significant set down in the MWL noted at Gage 3, while there was no significant change in the water surface elevation recorded at Gage 4 (see Figure 12).

The facilitation of setup at Gages 1 and 2 during Test 3 were likely related to the wave-overtopping and structurally-induced wave breaking across the ReefBLKSM breakwater segment; the freeboard of the modeled ReefBLKSM breakwater in Test 3 was 0.057 m (2.25 in) above the SWL of the wave basin. Additionally, the increase in the average water surface elevation at Gage 1 during Test 3 also represents the combined effect of wave reflections, H_{re} , as the incident wave height, H_i , connected with the ReefBLKSM breakwater and was returned.

Test 4 revealed the largest increase in the MWL observed from all laboratory experiments, which occurred at Gage 1, incident to the modeled ReefBLKSM breakwater segment. Test 4 also revealed that there was statistically significant set down in the mean water surface elevation at Gages 2 and 3 (see Figure 11). Test 4 additionally showed setup occurring at Gage 4, nearest the sand beach (shoreline). During Test 4 the SWL (0.21 m) was approximately equal to the simulated wave height (0.21 m). A common coastal engineering rule of thumb suggests that the largest wave height capable of occurring at a given water depth is estimated to be no greater than 90% of the water depth of the given location (Sorensen 2006). During Test 4 it was noted that the instability of the wave height forced waves to break prior to reaching the ReefBLKSM breakwater. Therefore, the response of the water surface elevation at Gage 1 in Test 4 was likely representative of depth-limited wave breaking.

Additionally, Test 4 had the highest examined freeboard of the modeled ReefBLKSM breakwater of all tested water depths, where the R_c was 0.09 m (3.63 in). Therefore, the increase in the water surface elevation at Gage 1 during Test 4 was likely representative of the additional effects from wave reflections, H_{re} , as the incident wave heights, H_i , connected with the ReefBLKSM breakwater and were returned. Additionally, setup in the MWL occurred at Gage 4 during Test 4, but this increase was not seen in Test 3, and both experiments investigated emergent breakwater conditions.

Results from laboratory tests of 1:2 (model: prototype) geometric scaled ReefBLKSM breakwater indicate the facilitation of wave-structure interactions that produced wave setup and set down of the MWL at locations incident and leeward of the breakwater segment. Because there was observed setup and set down of the MWL at gage placement locations during laboratory testing, laboratory results were additionally compared to the predicted level of setup rendered by the Diskin et al. (1970) equation (Equation 3). Comparison of measured setup data with Equation 3 were investigated to determine if Equation 3 could correlate and predict the magnitudes of wave setup observed during laboratory testing of the scale model ReefBLKSM breakwater segment.

Observed laboratory results, however, did not correlate with the levels of setup predicted by Equation 3 for any tested gage location or water depth condition (see Figure 13). Laboratory results (see Figure 12) showed that the largest magnitudes of wave setup observed in the leeward region of the scale model ReefBLKSM breakwater, Gages 2, 3, and 4, occurred when the ReefBLKSM breakwater was submerged, i.e. during Test 1 and Test 2. This contradicted what was predicted by Equation 3, which suggested lower values of setup when the breakwater was submerged then when it became slightly

emergent (see Figure 13). It was found that Equation 3 overestimated the level of setup observed during the laboratory experiments conducted in this study. This was likely due to differences in experimental setup between this study and that of Diskin et al. (1970), in which this study allowed for water return flows around the end of the modeled breakwater segment. Therefore, Equation 3 is not recommended for use as a predictive estimate of wave setup behind low-crested oyster reef breakwaters such as ReefBLKSM.

The experiments conducted in this laboratory study suggest a potential concern for the applications of low-crested oyster reef breakwaters used in living shorelines stabilization projects. Specifically, the results of four tested water depths suggest that there was sensitivity surrounding the freeboard of the modeled ReefBLKSM breakwater and the structure's ability to induce wave setup, particularly at locations nearest the sand beach. Three of the four water depth tests performed in this study, emergent and submerged conditions, revealed statistically significant increases in the water surface elevations at Gage 4, located nearest the sand shoreline. The limited laboratory tests conducted in this study of a scaled ReefBLKSM breakwater segment, qualitatively suggest that this particular oyster reef structure was capable of facilitating nearshore hydrodynamic interactions that resulted in localized increases in the water surface elevation, particularly in areas nearest the shoreline. Although, the observed magnitudes of setup in the laboratory experiments were lower than the range of concern for vegetated shorelines as suggested by Morris et al. (2002). Furthermore, results showed the need to develop a predictive equation for wave setup that correlates wave characteristics, nearshore placement, and the structural properties of this technology.

FIELD OBSERVATIONS

The living shoreline project site investigated in this study is a 1 km (0.62 mile) shoreline located at Alabama Port, Alabama which is situated on the southwestern shore of Mobile Bay. Mobile Bay is classified as a diurnal, microtidal, estuarine environment, meaning it experiences one high and one low tide per day of less than 1 m (3.28 ft). Alabama Port is a unique marsh and sandy beach shoreline given that it is exposed to lengthy fetches across Mobile Bay to both the northeast, approximately 38 km (23.6 miles), and the southeast, with fetch distances extending out into the Gulf of Mexico through the mouth of Mobile Bay. The perpendicular fetch length at Alabama Port is approximately 28 km (17.4 miles) to the southeast (115° N).

Perpendicular fetch length is important to consider in the designs of shoreline stabilization and protection projects since waves approaching directly normal to the coast maximize the potential development of onshore momentum fluxes. Shore-directed momentum fluxes directly control the facilitation of wave setup when waves actively break nearshore and over submerged low-crested breakwater structures (Calabrese et al. 2003). It is also known that longer fetch distances have the potential to develop larger wind driven wave heights than smaller fetch lengths when considering wave generation which is not duration limited (Sorensen 2006). This means that the most energetic waves (largest wave heights) occurring normally incident to a shoreline have the potential to

develop from increased perpendicular fetch length. These large shore normal wave heights are capable of producing larger shoreward fluxes of momentum upon wave breaking, and potentially develop the largest magnitudes of wave setup.

Historically, the shoreline at Alabama Port has consisted of coastal wetland habitat situated landward of a protective sandy beach barrier (see Appendix A2). Over recent decades the wetland's protective sandy beach barrier has continued to erode and recede, exposing more of the fringe marsh area to the direct forces of waves and tides. The site has experienced storm effects (surges, increased waves, etc.) from Tropical Storm Lee (early September 2011) and Hurricane Isaac (late August 2012) since the placement of the breakwater field at Alabama Port in early 2011. It is however unclear if damage to the leeward marsh and sandy shoreline observed after these events was the result of wave setup effects stemming from wave-structure interactions or an increase in wave energy during the storms. It is also unclear if the continued erosional trend of the shoreline at Alabama Port is controlled by the occurrence and damages obtained during these more extreme weather conditions or if the trend of the shoreline is controlled by more frequently occurring events.

In an effort to prevent further shoreline erosion and increase oyster habitat, six low-crested oyster reef breakwater segments were constructed along the shoreline at Alabama Port. According to McKee (2010), the previous placement of two low-crested oyster reef breakwaters (Scyphers et al. 2011) controlled the layout and placement of the additional six oyster reef breakwater segments added to the site location in spring 2010. The six oyster reef breakwater segments at Alabama Port consist of three reef designs: ReefBLKSM, Reef BallTM, and bagged oyster shell. Each breakwater segment is

approximately 125 m long with offshore placement 30 m from the original shoreline.

The entire breakwater field installation was completed in April 2011 (Heck et al. 2012).

Additional information on the layout and design of the breakwaters located at the Alabama Port living shoreline project site can be found in McKee (2010).

In spring, typical weather front patterns produce the strongest yearly winds from the southerly and southeasterly direction for Mobile Bay (Kimball 2011). Winds occurring from the southerly and southeasterly direction approach the shoreline at Alabama Port perpendicularly, and therefore have the potential to develop large shore normal waves and shoreward fluxes of wave related momentum. The subsequent section discusses the methodology of this study's investigation of wave setup behind the prototype ReefBLKSM breakwater segment at Alabama Port, which is suggested to develop from sustained southeasterly winds known to occur during spring.

FIELD METHODOLOGY

Month-long monitoring of the wave and water level climate was conducted in May 2015 near the northern ReefBLKSM breakwater segment at Alabama Port (see Figure 14). This breakwater segment was selected for monitoring because the marsh shoreline leeward of this low-crested oyster reef breakwater shows distinctive characteristics of an erosional marsh. Heck et al. (2012) suggest that the greatest average distance of shoreline loss at the Alabama Port living shoreline project is behind this breakwater. Appendix A3 shows a photograph of the erosive marsh shoreline located leeward of the monitored ReefBLKSM breakwater segment taken March 1, 2013, nearly three years after the breakwater segment was installed. It is suggested that structure-induced wave setup produced during strong southeasterly winds is causing frequent increases in the MWL, leading to the continued degradation and destruction of the leeward shoreline and marsh habitat.

The length of the monitored ReefBLKSM oyster reef breakwater segment, L_s , is 125 m (410 ft). The crest width, B_c , is 2.64 m (8.66 ft), and is defined as the furthest perpendicular crest width measured between two adjacent units. The breakwater structure height, h_c , is 0.61 m (2 ft), with an average crest elevation of 0.03 m relative to the North American Vertical Datum of 1988 (NAVD 88). The original placement of the ReefBLKSM breakwater as described in McKee (2010) is 30 m (98 ft) from the initial

shoreline location given as, X. Gap widths, L_g , of 12.5 m (41 ft) separate this continuous breakwater from neighboring breakwater treatments at both ends of the structure.

Definition sketches of the ReefBLKSM breakwater parameters are illustrated in Figure 15 and Figure 16.

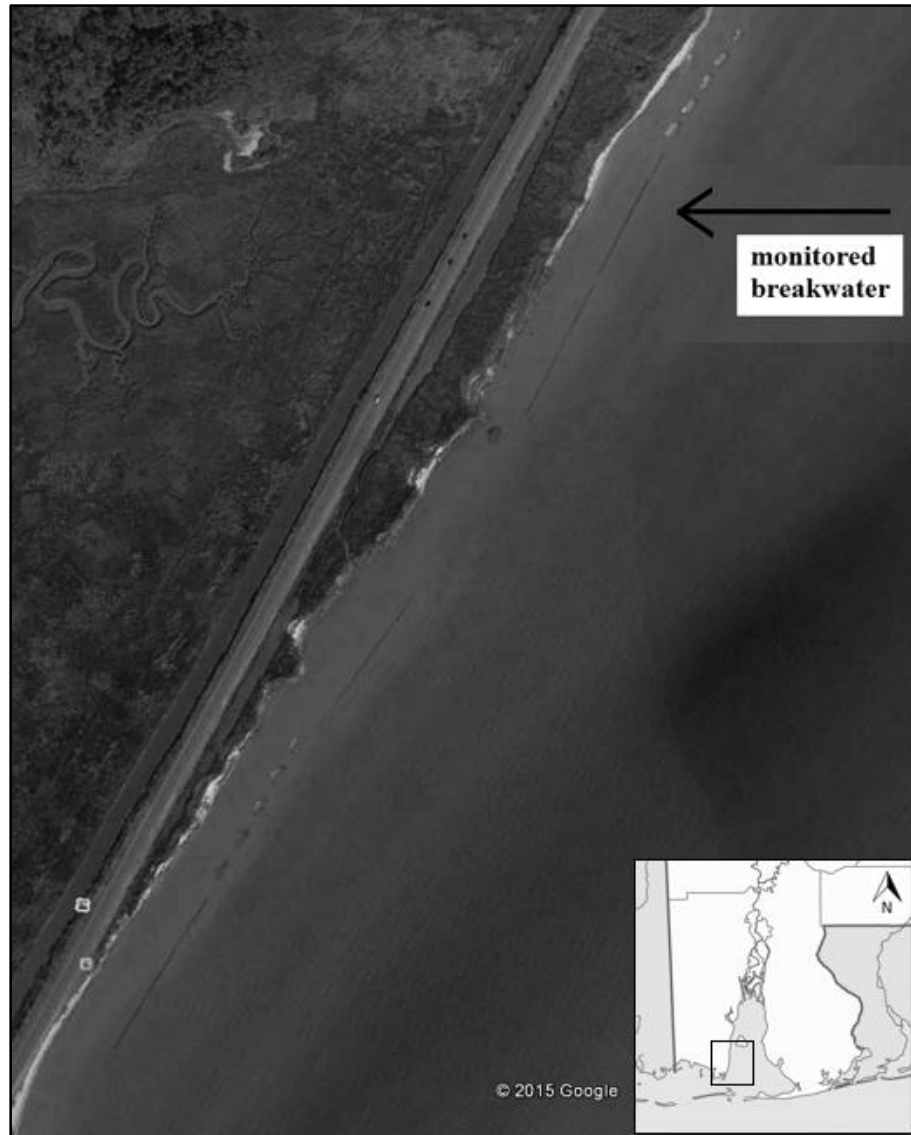

Figure 14. Alabama Port living shoreline project site located on the western shore of Mobile Bay, Alabama (Image © 2015 Google).

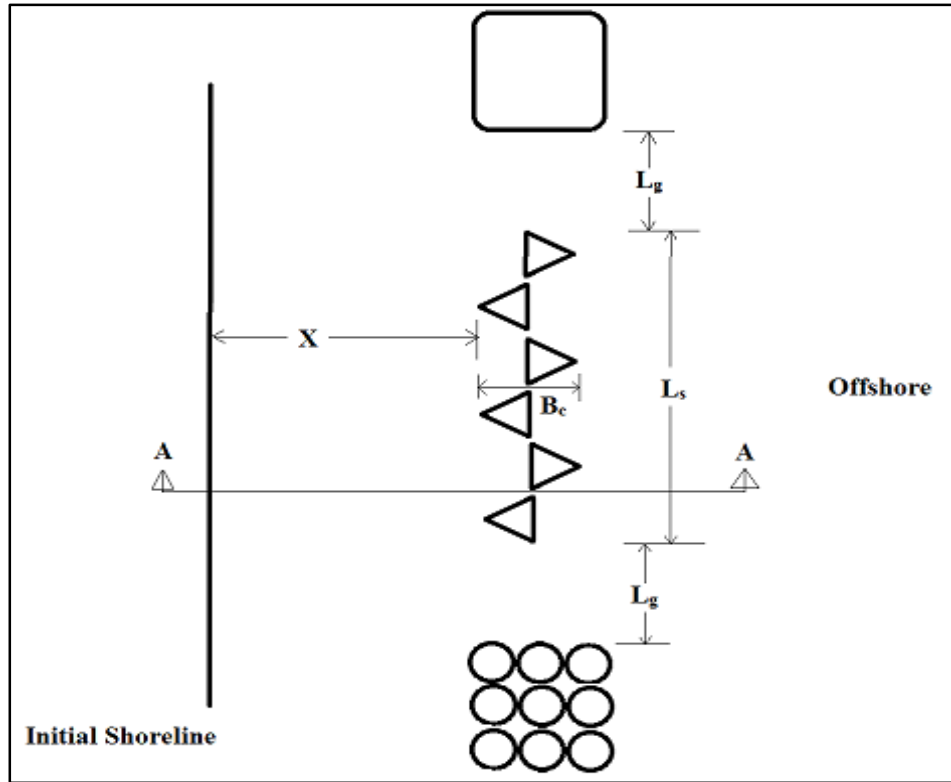

Figure 15. Plan view with definition sketch of the ReefBLKSM breakwater parameters (Figure is not drawn to scale).

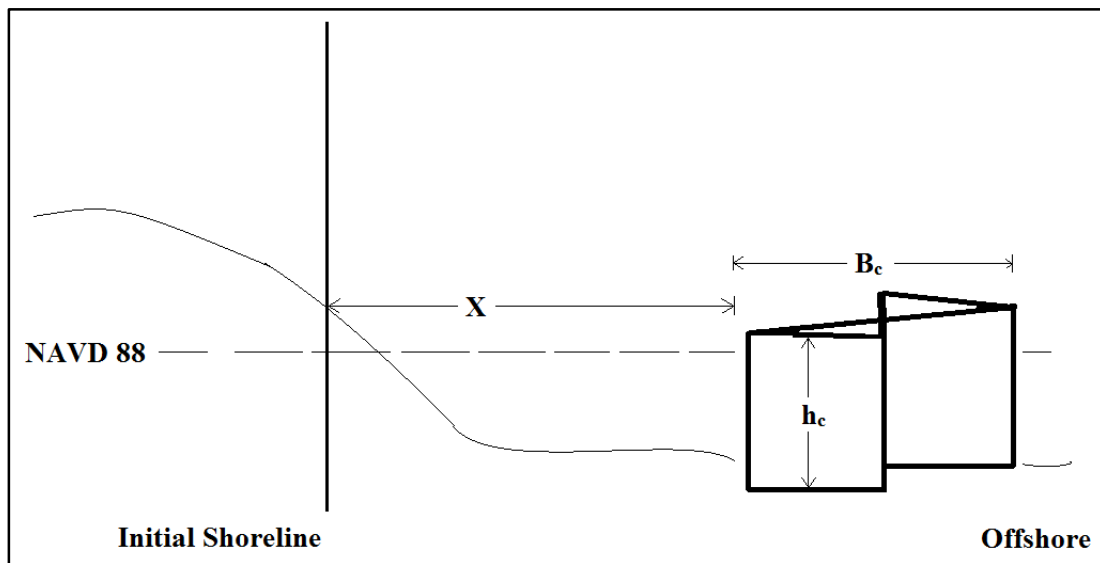

Figure 16. Cross-sectional view at Transect A (see Figure 9) with definition sketch of the ReefBLKSM breakwater parameters (Figure not drawn to scale).

To evaluate the wave-structure interactions of the ReefBLKSM breakwater potentially facilitating wave setup, measurements of the site's wave climate, mean water levels, and breakwater characteristics were collected. To collect information on the site's wave climate and water levels four pressure sensors, RBR*virtuoso* D |wave recorders, were deployed along two shoreline profiles for nearly a month, 669 hours (27.875 days) (see Figure 17). Profile 1 was located perpendicular to the centerline of the northern ReefBLKSM breakwater segment, approximately 62.5 m (205 ft) from either end of the shore-parallel structure. Profile 2 was located north of the breakwater field at Alabama Port, also perpendicular to the shoreline. Three of the four pressure sensors were placed along Profile 1, while the last pressure sensor was placed along Profile 2 (see Figure 17). Profiles 1 and 2 at Alabama Port were surveyed at the beginning and end of the May 2015 monitoring study through the use of real time kinematic global positioning system (RTK-GPS) equipment. RTK-GPS equipment was also used to determine sensor location coordinates and sensor placement elevations above the bay bed bottom, which were then used to establish the water surface elevations at the gage locations during the deployment period. Appendix Figure A4 shows the mounts used to hold and secure the sensors during the deployment.

The first pressure sensor, Sensor 1, was placed nearest the shore at an elevation of -0.19 m NAVD 88, and was the most landward sensor located along Profile 1 (30°20'58.20"N, 88°7'15.56"W). The second pressure sensor, Sensor 2, was deployed directly leeward from the center of the ReefBLKSM breakwater along Profile 1 (30°20'58.02"N, 88°7'15.12"W) at an elevation of -0.28 m NAVD 88. The third pressure sensor, Sensor 3, was placed directly seaward from the center of the ReefBLKSM

breakwater along Profile 1 (30°20'57.64"N, 88°7'14.39"W) at an elevation of -0.51 m NAVD 88. The fourth pressure sensor, Sensor 4, was placed at a seaward position along Profile 2 (30°21'5.20"N, 88°7'8.70"W) at an elevation of -0.41 m NAVD 88. Figure 17 provides an illustration of the survey profile transects, Profiles 1 and 2, and placement locations for the four pressure sensors, Sensors 1, 2, 3, and 4.

Each of the four sensors were programmed to take 512 absolute pressure reading samples at a rate of 6 Hz, with measurement bursts occurring every six minutes for the deployment period. This sampling regime was selected to maximize the sensor's ability to obtain and store information. Following the month deployment period sensors were retrieved and data were then exported using the sensor manufacturer's software, Ruskin, for further analysis in Microsoft Excel. Sensor data exported from the Ruskin software included the mean water depth, which was converted to mean water levels (MWL) relative to NAVD 88, average wave height and wave period, H_{avg} and T_{avg} respectively, and wave energy, E . For more information on how the Ruskin software converts the absolute pressure readings to develop these wave characteristic statistics see Gibbons et al. (2005).

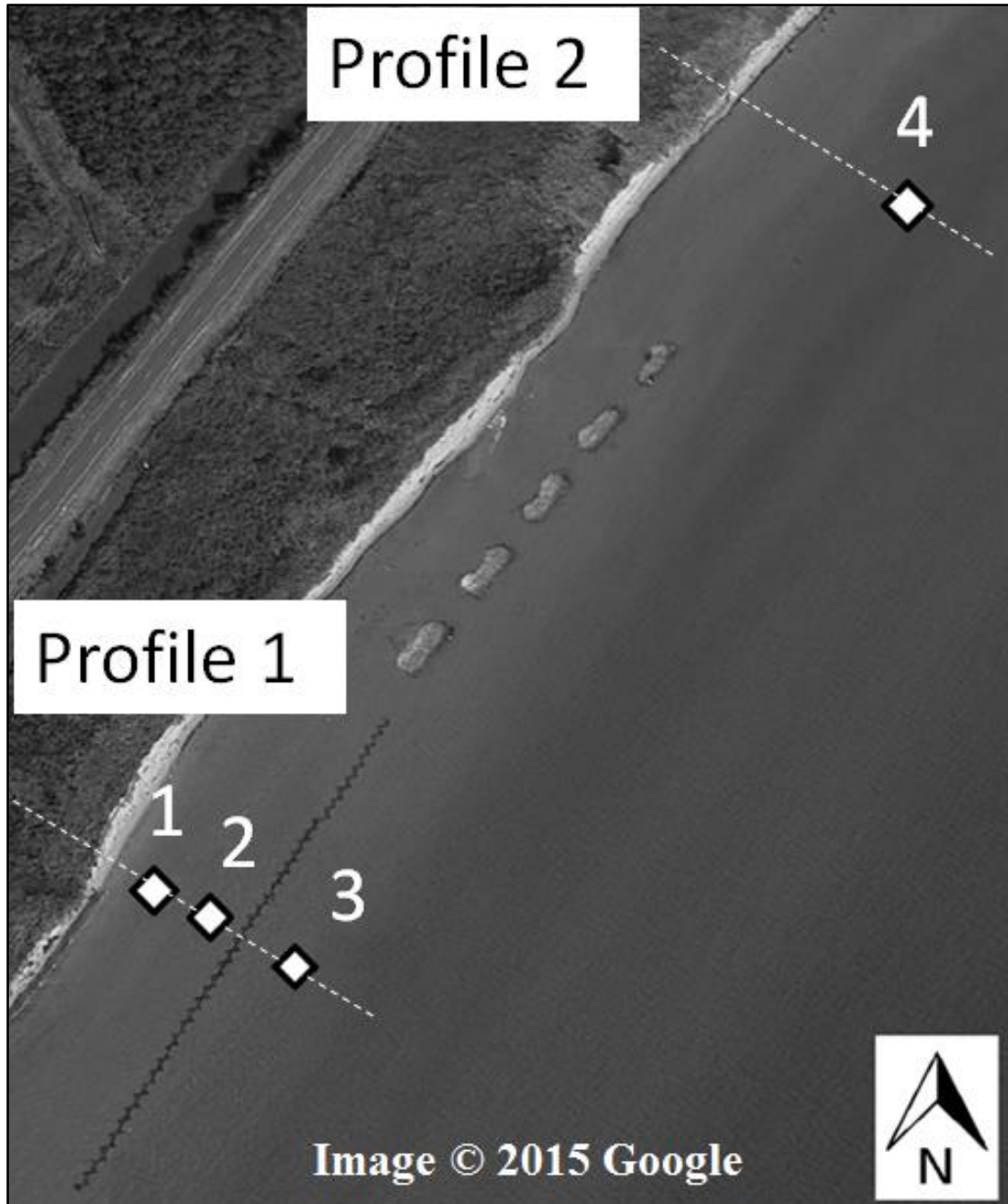

Figure 17. Surveyed beach profiles and placement locations of the pressure sensors at Alabama Port, AL (Image © 2015 Google).

To investigate the potential development of wave setup at the Alabama Port living shoreline project site water surface elevation data were first examined in thirty-minute increments over the entire sensor deployment period (May 1- May 29, 2015). Further examination of the water surface elevation data were performed based on segmented consecutive days of data, which were determined from recorded wave energy levels, classified as energetic or calm conditions (see Table 4). Classification of the wave energy into time periods of energetic and calm conditions was done through the author's visual inspection of Sensor 3's wave energy records for the entire month-long deployment duration (see Figure 18). The time period segments established by the author from Figure 18 are given in Table 4. The time segments are noted to correspond with peak wind periods observed at nearby NOAA weather monitoring stations at Dauphin Island to the southeast and Cedar Point to the southwest.

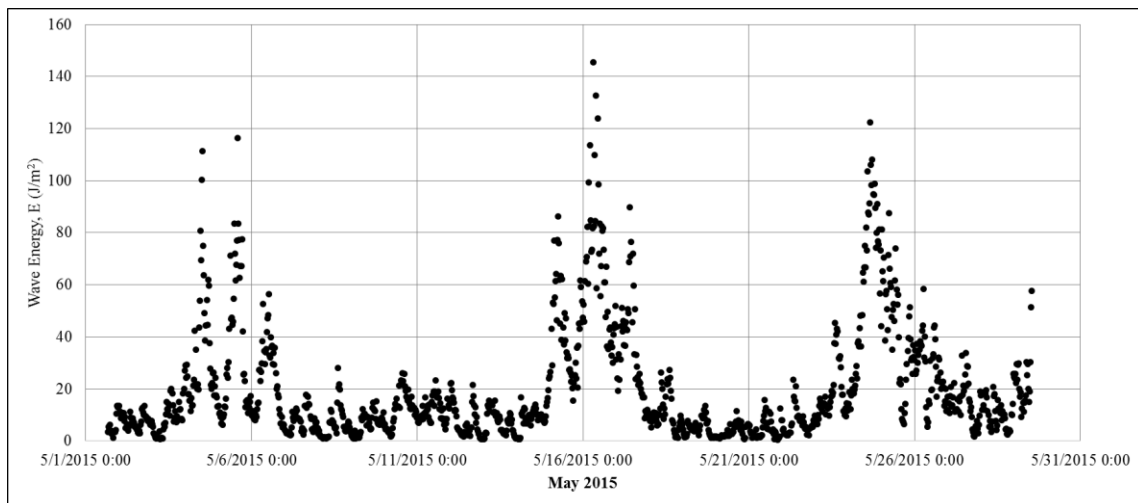

Figure 18. The wave energy record for Sensor 3 at Alabama Port, Alabama during May 2015.

Table 4. Water surface elevation data analysis scheme for the Alabama Port living shoreline project site.

Total Deployment Duration		Energetic Wave Durations		Calm Wave Durations	
TD	May 1 – May 29	E1	May 3 – May 7	C1	May 1 – May 3
		E2	May 13 – May 18	C2	May 8 – May 12
		E3	May 22 – May 29	C3	May 19 – May 21

The MWL data recorded at the sensor locations for the time segments described in Table 4 were examined through use of single factor ANOVAs. A confidence interval of 95 % ($\alpha = 0.05$) was used for all ANOVA tests conducted in this field study. The null hypothesis, H_0 , given by Equation 5, was used to assess field monitoring results,

$$H_0 : \overline{\eta}_{\text{Sensor 1}} = \overline{\eta}_{\text{Sensor 2}} = \overline{\eta}_{\text{Sensor 3}} = \overline{\eta}_{\text{Sensor 4}} \quad (\text{Eq. 5})$$

where the average water surface elevations, $\overline{\eta}$, recorded at each gage were considered equal to one another. For example, the MWL at Sensor 1 was equal to Sensor 2, Sensor 3, and Sensor 4. Failure to reject the null hypothesis, H_0 , would indicate that there was no statistically significant setup or set down in the mean water level measured at the sensor locations. Rejection of the null hypothesis would indicate that there was a significant difference between the means of the water surface elevations recorded at the sensor locations. Rejection of the null hypothesis indicates that there was at least one inequality that existed between the MWL's recorded at the sensors, suggesting setup or set down of the water surface occurred at a minimum of one of the sensor locations.

FIELD RESULTS

This section presents and describes the analysis of sensor and surveyed profile data of the monitored ReefBLKSM breakwater segment collected during May 2015 at the Alabama Port living shoreline project site. The water surface elevations recorded at the sensor locations for the month-long investigation are provided in Figure 19. Further investigation into the observed differences in the water level data between Sensor 1 (nearest the shoreline) and Sensor 3 (incident to the breakwater) are presented in Figure 20. The monitored shoreline profiles, Profiles 1 and Profile 2 are given in Figure 21 and Figure 22 respectively. Water surface elevations were further examined through the use of single factor ANOVAs. Results from the single factor ANOVA tests on the MWL changes observed for the segmented deployment durations (see Table 4) are given in Table 5.

Table 5. P-values for the single factor ANOVA field tests.

Deployment Duration	P-Value	95 % Confidence Interval
TD	0.98	0.05
E1	0.98	0.05
E2	0.98	0.05
E3	0.99	0.05
C1	0.96	0.05
C2	0.99	0.05
C3	0.98	0.05

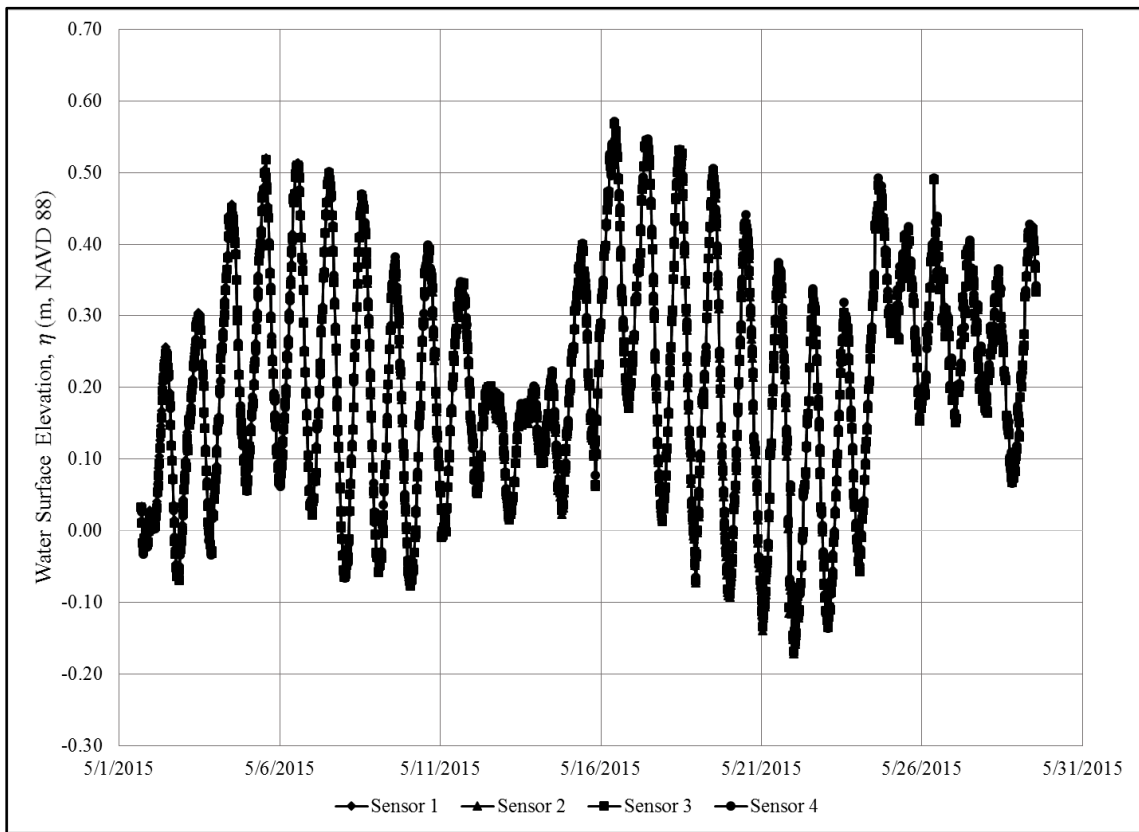

Figure 19. Recorded water level time series data at sensor locations during May 2015.

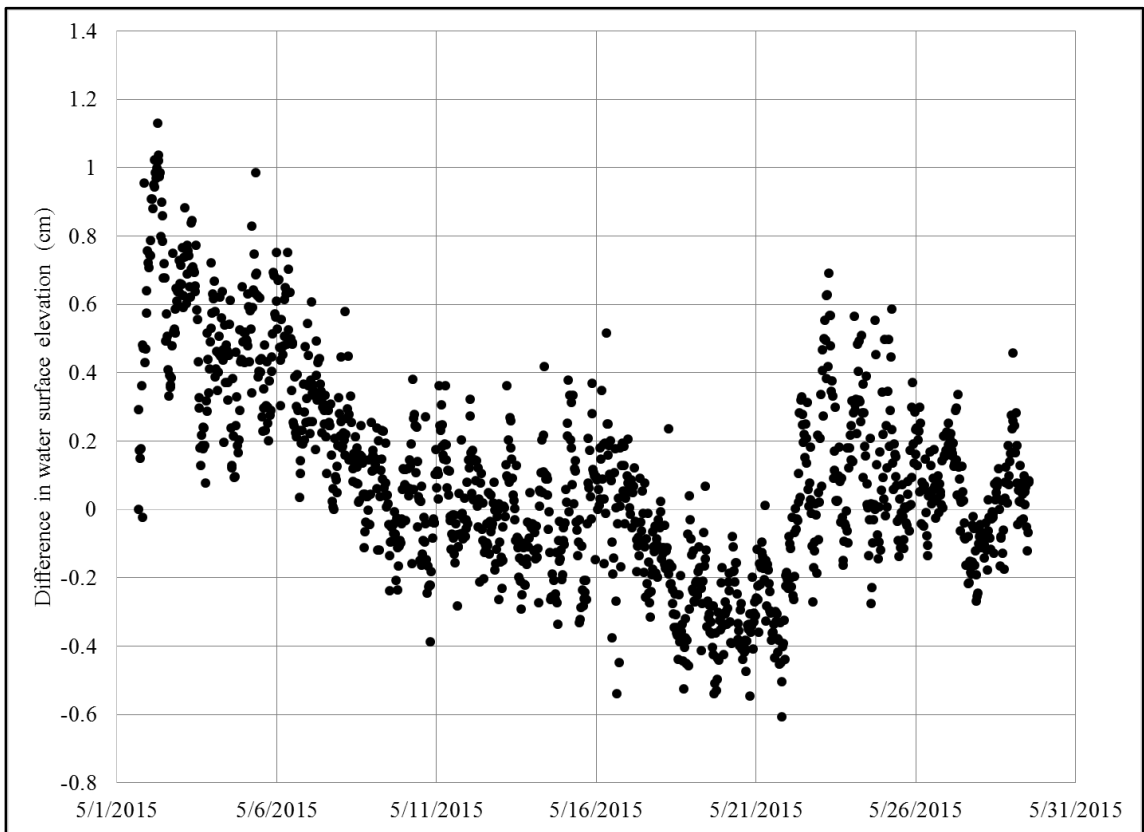

Figure 20. Difference in water surface elevation during May 2015 from inside and outside (Sensor 1 – Sensor 3) the monitored reef breakwater segment.

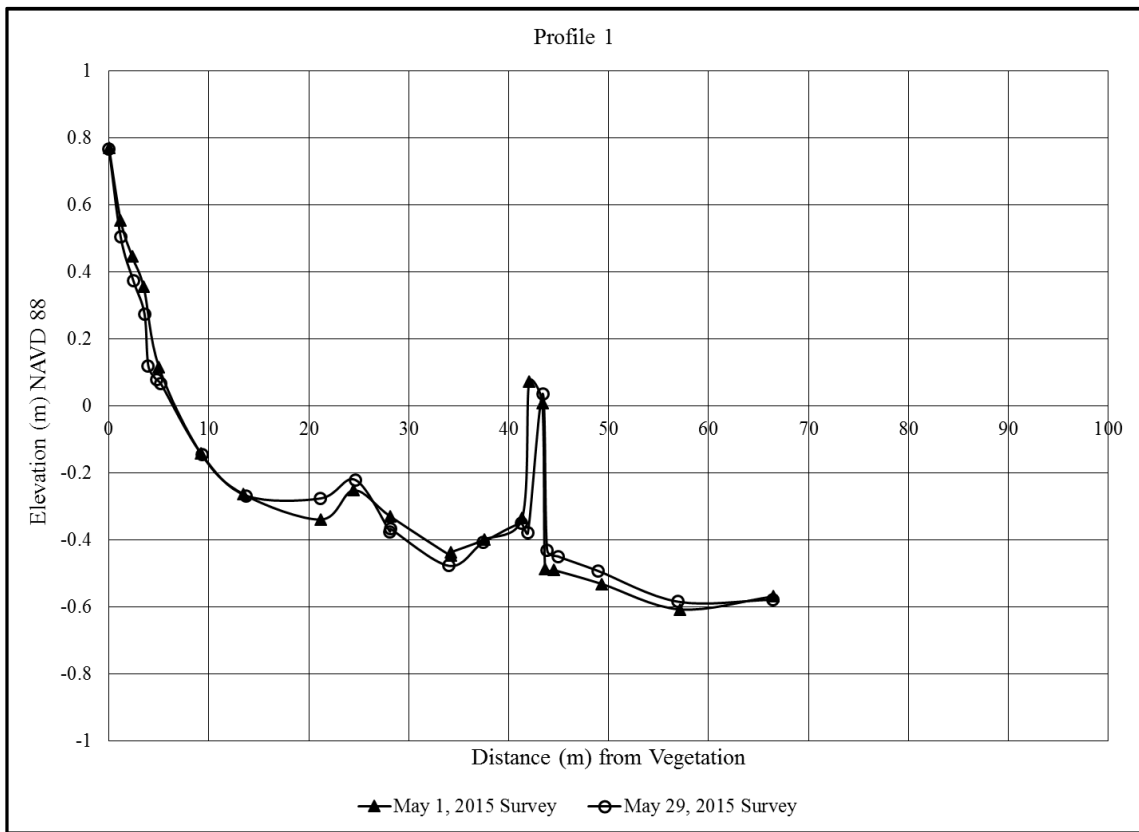

Figure 21. Transect survey data for Profile 1, Alabama Port, Alabama.

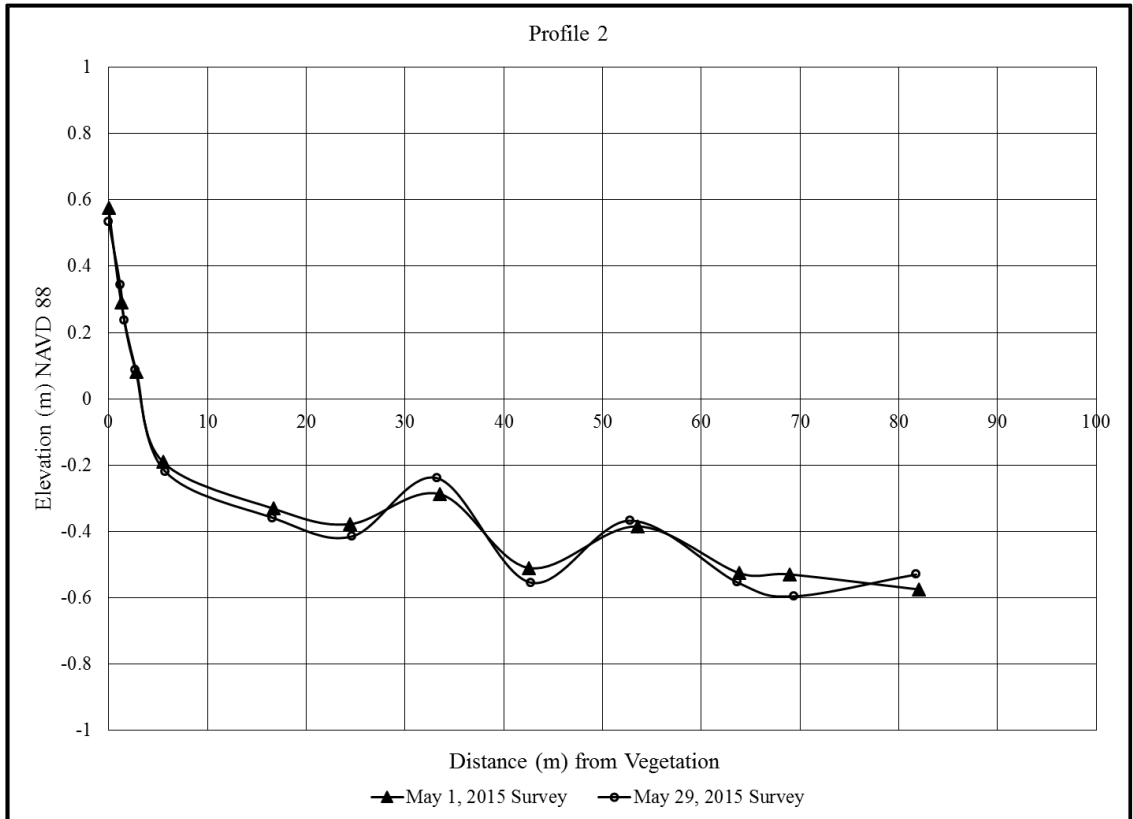

Figure 22. Transect survey data for Profile 2, Alabama Port, Alabama.

Additionally, the wave attenuating capability of the monitored ReefBLKSM breakwater segment at Alabama Port was also assessed. Assessment of the monitored ReefBLKSM breakwater segment’s ability to attenuate wave energy was determined through the use of Equation 2. The average wave heights, H_{avg} , of Sensors 2 and 3 were compared at thirty-minute time intervals for the entire month of May 2015 to determine the transmission coefficients, K_t , the ratios of transmitted wave height to the incident wave height. Figure 23 graphically presents the transmission coefficient, K_t , data of the monitored ReefBLKSM breakwater segment at Alabama Port. Figure 23 shows that when the ReefBLKSM breakwater was submerged (85% of the monitoring period), indicated by

unfilled circles, the average transmission coefficients was 0.78. Likewise, Figure 23 shows that when the ReefBLKSM breakwater was emergent (15% of the monitoring period), indicated by filled triangles, the average transmission coefficients was 0.45.

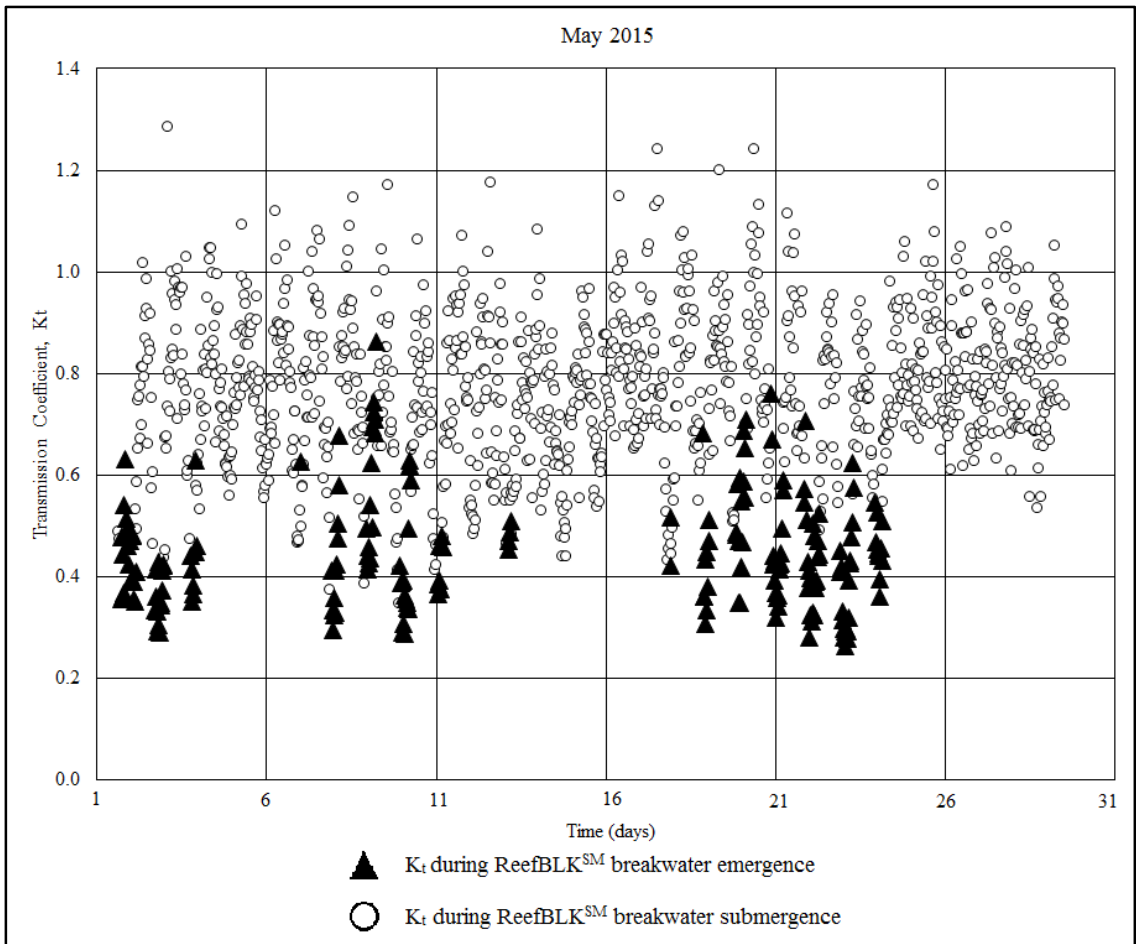

Figure 23. May 2015 transmission coefficients, K_t , of the monitored ReefBLKSM breakwater segment at Alabama Port, Alabama.

Wave height data collected from Sensor 3 was compared to a thirteen year hindcasted wave climate developed by Roland and Douglass (2005) for the project's monitoring site location at Alabama Port. A graphical comparison of May 2015's

incident wave climate to the site's historical wave climate estimations are presented in Figure 24.

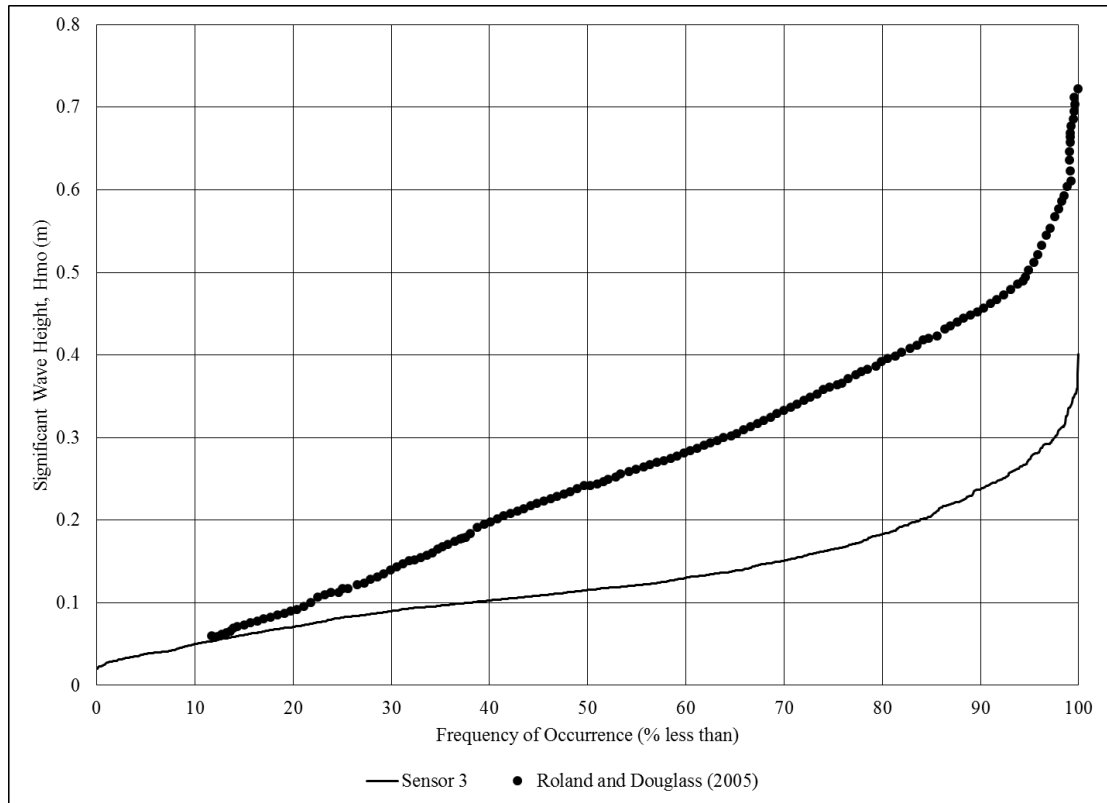

Figure 24. Significant wave height frequency of occurrence (less than) observed during the May 2015 monitoring study compared to the frequency of significant wave height occurrence (less than) developed for Alabama Port, AL by Roland and Douglass (2005).

FIELD DISCUSSION

Surveyed shoreline profiles, Profile 1 and Profile 2, both indicated erosion of the foreshore area of the shoreline and the building of an offshore bar (see Figure 21 and Figure 22). Profile 1 revealed elevation increases at trough locations of the offshore bars. Accretion was also observed on the seaward side of the low-crested oyster reef structure (see Figure 21). The author anecdotally suggests that the observed sediment accretion on the seaward side of the structure in Profile 1 indicates that the structure is blocking the natural cross-shore sediment transport. A second offshore bar was reported along Profile 2 (see Figure 22), which was not observed along Profile 1. The author suggests that the discrepancy between the numbers of offshore bars between the monitored profiles provides additional anecdotal evidence that the low-crested breakwater field is blocking the migration of the second bar. The building of offshore bars are important mechanisms for cross-shore sediment transport. Based on surveyed data collected in this study, the low-crested oyster reef breakwaters located at Alabama Port appear to interfere with this process.

Visual comparison of the individual water level time series data do not indicate observable changes between the sensor's recorded water surface elevations (see Figure 19). Table 5 revealed that for every examined duration the P-value obtained from the single factor ANOVA was greater than the confidence interval. This means that the null

hypothesis (see Equation 5) was not rejected for any deployment duration. This suggests that there were no statistically significant changes in the MWLs observed between the sensors for any investigated duration of water surface elevation data. Failure to reject the null hypothesis (Equation 5), as suggested by the results of the P-values (see Table 5), show that regardless of how the MWLs were assessed in various time segments there were no significant differences between the means of the water levels recorded at any of the sensor locations. This suggests that the MWL recorded for any given period of time during May 2015 at sensors 1, 2, 3, and 4 equaled the MWL recorded at all other sensor locations. Additionally, the change in water surface elevation was further investigated through a comparison of water surface elevation differences between Sensor 1 (nearest the shoreline) and Sensor 3 (incident to the breakwater segment). Figure 20 shows that during May 2015 the greatest increase in MWL at Sensor 1 for any 30-minute time period compared to Sensor 3's MWL was only 1 cm. The results from Table 5 and Figure 20 therefore conclude that setup was not observed in the month-long field monitoring study conducted in May 2015 at the ReefBLKSM breakwater segment at Alabama Port.

The lack of observed setup in the MWL leeward of the monitored ReefBLKSM breakwater segment is likely explained by the results of the structure's wave attenuation capabilities (see Equation 1). Figure 23 graphically depicts the wave transmission rates determined from Equation 1, which used the average wave heights, H_{avg} , observed at incident and leeward locations, Sensors 3 and 2 respectively, of the ReefBLKSM breakwater segment. This procedure conducted in this study, is questionable since there was a water depth difference of 0.23 m (9 in) between sensors locations, which could

suggest the additional effects of wave shoaling. Additionally, the short-crested nature of the waves likely limited wave attenuation, breaking, and setup that could potentially develop under more energetic conditions.

Figure 23 reveals that the monitored ReefBLKSM breakwater segment was submerged 85% of the May 2015 sensor deployment time period, which indicates that the monitored ReefBLKSM breakwater segment was emergent only 15% of the May 2015 sensor deployment time period. This suggests that while the ReefBLKSM breakwater segment was capable of attenuating 55% of the average incident wave height, H_{avg} , this level of attenuation was only achieved 15% of the monitoring time conducted during this study, and typically when wave heights were naturally reduced by depth-limited wave breaking. Additionally, Figure 23 suggests that more often, 85% of the monitoring period, nearly 78% of the average incident wave height, H_{avg} , was transmitted leeward of the ReefBLKSM breakwater.

The poor wave height reduction observed over the month long monitoring period suggest that waves did not actively break over the top of the low-crested and mostly submerged ReefBLKSM breakwater segment. Therefore, Equation 2 indicates that there will not be a large development of wave setup leeward of the breakwater without active wave breaking over and across the structure. Equation 2 is highly sensitive and dependent on a reduction in the wave height leeward of the structure compared to the wave heights occurring incident to the structure. When there is little wave attenuation as was observed over May 2015 (see Figure 23), then minimal magnitudes of wave setup/water ponding are predicated by Equation 2.

Further analysis of the field data with Equation 3 could not be conducted because there was no statistically significant measures of setup in the MWLs recorded by the sensors during the monitoring period. Comparisons of observed wave height data with a thirteen year hindcasted data set (see Figure 24), suggest that the significant wave heights that occurred incident to the shoreline at Alabama Port in May 2015 were much less than predicted, historical wave heights. However, this comparison is questionable since measured wave climate data are not likely to agree with wave climate data developed from the simplified assumptions used in wind-wave hindcast models. It is unclear from the field monitoring data collected in this study if wave setup leeward of the ReefBLKSM breakwater segment can potentially develop under a stronger incident wave climate than was observed during May 2015.

It should be mentioned that errors in assessing and establishing the elevation of mounted sensors could have removed magnitudes of setup which possibly occurred during the May 2015 monitoring study. The relative error associated with RTK-GPS equipment is on the order of millimeters. However, in the soft muddy bay and marsh shoreline environment investigated in this study, human-introduced measurement error of the RTK-GPS equipment can be larger than 5 cm (2 in). This level of error is on the same order of magnitude as the level of setup attempted to be investigated in this field study, and is also within the reported range of sensitivity for fringe wetland vegetation, 5-10 cm (2-4 in) (Morris et al. 2002). It is suggested by the author that future studies take great care in establishing sensor locations so that assessment of the mean water levels can accurately quantify changes between sensor locations that are only representative of changes in MSL and not inclusive of experimental errors.

CONCLUSIONS

Wave setup is a well noted coastal engineering design concern affecting shoreline stabilization projects, capable of controlling or limiting the outcome of shoreline protection projects which include low-crested breakwaters. While wave setup is a known response of water levels to low-crested breakwaters, it is still not well understood and infrequently documented. Likewise, there are also large gaps in the scientific understanding and capabilities of newly emerging low-crested oyster reefs breakwater technologies, such as ReefBLKSM, which are incorporated into nature based shoreline stabilization projects known as living shorelines. To the author's present knowledge, low-crested oyster reef breakwaters, such as ReefBLKSM, have not been investigated in terms of their abilities to interact with nearshore hydrodynamics to facilitate effects related to wave setup (i.e., the ponding of water and nearshore current generation).

It was suggested that structure-induced wave setup produced during strong southeasterly winds was causing frequent increases in the MWL, leading to the continued degradation and destruction of the leeward shoreline and marsh habitat. The lab results indicate a potential for setup to occur behind these structures, but significant magnitudes setup were not observed in one month of data collected at the field site. While wave setup may exist at the site, it may not be happening as frequently as originally thought, but it is possible that wave setup could be occurring during more infrequent events such

as storms. However, laboratory tests and May's monitored field data at Alabama Port did indicate similar magnitudes of setup. This was a unique finding since irregular sea waves typical of bays as observed at the field site during May 2015 were dissimilar from monochromatic waves forced during scale model laboratory testing.

The wave measurements from the field study show that the wave energy at the site is low enough to support a vegetated shoreline according to Roland and Douglass (2005). However, this qualification is based on a month of monitored data, which cannot report on annual or seasonal variations of the system. Surveyed profile data show continued loss of sediment in the foreshore region. The dominant direction of sediment transport at Alabama Port is from south to north. However, there is very little available sediment in the south part of the shoreline system due to the presence of a rock revetment. Therefore, it is unclear if the continued negative response of the shoreline at Alabama Port represents a thinning marsh-backed sandy shoreline that is running out of sediment, or response to nearshore hydrodynamic interactions not captured in this study.

This is the first known study to investigate the facilitation of wave setup induced water ponding/ piling-up behind an oyster reef breakwater design in a laboratory setting. Limited laboratory tests of a 1:2 (model: prototype) scaled ReefBLKSM breakwater segment conducted in this study reveal that the structure is capable of inducing localized changes in mean water surface elevation. However, results of observed setup and set down during laboratory experiments were extremely variable with regards to the freeboard of the ReefBLKSM structure, and should undergo further research investigations. Laboratory data also revealed that an equilibrium of the MWL had not been reached, suggesting the need to run experiments for longer durations. Additionally,

the author concludes that Equation 3 is an insufficient tool for estimating wave setup leeward of low-crested oyster reef breakwaters such as ReefBLKSM.

Collected field data at Alabama Port suggest that there were not significant changes in the MWLs recorded by the sensors during May 2015. It is unclear if introduced experimental errors contributed to this qualification of the field monitoring study. It is also unclear if monitored ReefBLKSM breakwater segment is capable of producing large hydrodynamic changes in the MWL given the low observed wave attenuation capabilities (see Figure 23). Monitored profile surveys suggest that the low-crested oyster reef structures have interfered with natural cross-shore sediment transport. However, because this study only compared a month of monitoring data these qualifications should undergo further long-term analysis. It is recommended that there be continued monitoring of the living shoreline breakwaters located at Alabama Port to better assess and investigate the hydrodynamic interactions and capabilities of these structures to further quantify the observations documented in this study.

RECOMMENDATIONS

A primary recommendation from the conclusion of this study advocates for continued research into the wave-structure interactions and capabilities of low-crested oyster reefs beyond the qualitative investigations performed. For example, future laboratory studies can investigate varied structural parameters and geometries, irregular wave forcings, variable water depths, etc. to expand knowledge on low-crested oyster reef breakwater designs. Conducting more scale model tests of the ReefBLKSM breakwater units will expand engineering design knowledge regarding the setup response of the ReefBLKSM technology, whose use can potentially control the shoreline stabilization outcomes of living shoreline projects which use this low-crested reef breakwater technology.

Additionally, it is recommended that long-term monitoring be continued at the field site investigated in this study. To the author's present knowledge this is the third study to date which has documented the wave climate of Mobile Bay, AL. The lack of wave climate data available for Mobile Bay presents a great challenge to coastal scientists and coastal engineers who require this information to make informed design decisions for coastal shoreline stabilization projects. Long-term monitoring is needed not only to develop a wave climate data set for Mobile Bay, but to also continue to

investigate the unique hydrodynamic interactions occurring leeward of the low-crested oyster reef breakwater field.

To better understand and use nature based technology it is recommended by the author that there be continued research into the wave setup and set down capabilities of newly emerging low-crested oyster reef breakwater technology used in shoreline stabilization projects. If nature based breakwater technologies are to be successfully incorporated into living shoreline stabilization projects, further research investigations on the facilitation of wave setup and unfavorable hydrodynamics associated with low-crested reef breakwaters, such as ReefBLKSM, are necessary.

REFERENCES

REFERENCES

- Allen, R. J. (2013). "Physical Modeling of Wave Transmission for Submerged and Emergent Breakwaters used in Living Shorelines." M.S. Thesis, University of South Alabama, Mobile, AL.
- Burcharth, H. F., Hawkins, S. J., Zanuttigh, B., and Lamberti, A. (2007). *Environmental Design Guidelines for Low Crested Coastal Structures*. Elsevier, Oxford, UK.
- Calabrese, M., Vicinanza, D., and Buccino, M. (2003). "2D Wave Set Up behind Low Crested and Submerged Breakwaters." *Proc., 13th International Offshore and Polar Engineering Conference*, Honolulu, HI, 831-836.
- Cappiotti, L., Sherman, D. J., and Ellis, J. T. (2012). "Wave Transmission and Water Setup Behind an Emergent Rubble-Mound Breakwater." *Journal of Coastal Research*, 29(3), 694-705.
- Dalrymple, R. A. and Dean, R. G. (1971). "Discussion of Piling-up behind Low and Submerged Permeable Breakwaters." *Journal of Waterways, Harbors, and Coastal Engineering Division*, 97(2), 423-427.
- Dalrymple, R. A. and Dean, R. G. (1991). *Water Wave Mechanics for Engineers and Scientists*. Prentice-Hall.
- Dean, R. G., Chen, R., and Browder, A. E. (1997). "Full Scale Monitoring Study of a Submerged Breakwater, Palm Beach, Florida, USA." *Coastal Engineering*, 29(3), 291-315.
- Dean, R. G. and Walton, T. L. (2009). "Wave Setup." *Handbook of Coastal and Ocean Engineering*. World Science, Hackensack, NJ.
- Diskin, M. H., Vajda, M. L., and Amir, I. (1970). "Piling-up Behind Low and Submerged Permeable Breakwaters." *Journal of Waterways, Harbors and Coastal Engineering Division*, 96(2), 359-372.
- Douglass, S. L. and Pickel, B. H. (1999). "The Tide Doesn't go Out Anymore: The Effects of Bulkheads on Urban Bay Shorelines." *Shore & Beach* 67(2&3), 19-25.

- Douglass, S. L. and Weggel, J. R. (1987). "Performance of a Perched Beach – Slaughter Beach, Delaware." *Coastal Sediments*, 1385-1398.
- Douglass, S. L., Ferraro, C., Dixon, C. R., Oliver, L., Pitts, L. (2012). "A Gulf of Mexico Marsh Restoration and Protection Project." *33rd International Conference on Coastal Engineering*. ASCE, Reston, VA, management.76.
- Gibbons, D. T., Jones, G., Siegel, E., Hay, A., and Johnson, F. (2005). "Performance of a New Submersible Tide-Wave Recorder." *Proc., MTS/IEEE, OCEANS*, 1057-1060.
- Hardaway, C. S. and Byrne, R. J. (1999). *Shoreline Management in Chesapeake Bay*. Virginia Institute of Marine Science, College of William & Mary, Special Report in Applied Marine Science & Ocean Engineering No. 356, 54p.
- Heck, K. L., Cebrian, J., Powers, S. P., Gericke, R. L., Pabody, C., and Goff, J. (2012). "Final Monitoring Report to the Nature Conservancy: Coastal Alabama Economic Recovery and Ecological Restoration Project: Creating Jobs to Protect Shorelines, Restore Oyster Reefs and Enhance Fisheries Productions." Dauphin Island Sea Lab and University of South Alabama. NA09NMF4630304.
- Jones, S. C., Tidwell, D. K., and Darby, S. B. (2009). *Comprehensive Shoreline Mapping, Baldwin and Mobile Counties, Alabama: Phase 1*. Alabama Geological Survey, Open-File Report 0921, Tuscaloosa, AL.
- Kimball, S. (2011). "Diurnal and Seasonal Variations in Wind Speed and Direction In and Around Mobile, Bay, Alabama." *Proc., 36th NWA Annual Meeting*, Birmingham, AL.
- Lamberti, A., Archetti, R., Kramer, M., Paphitis, D., Mosso, C., and Di Risio, M. (2005). "European Experience of Low Crested Structures for Coastal Management." *Coastal Engineering*, 52(10), 841-866.
- Longuet-Higgins, M. S. (1967). "On the Wave-Induced Difference in Mean Sea Level between the Two Sides of a Submerged Breakwater." *Journal of Marine Research*, 25(2), 148-153.
- Loveless, J. H. and MacLeod, A. B. (1999). "The Influence of Set-Up Currents on Sediment Movement behind Detached Breakwaters." *Coastal Sediments*, ASCE, 2026-2041.
- McKee, J. (2010). "Analysis and Design Plan Coastal Alabama Economic Recovery and Ecological Restoration Project." Dauphin Island Sea Lab.

- Morris, J. T., Sundareshwar, P. V., Nietch, C.T., Kjerfve, B., and Cahoon, D. R. (2002). "Responses of Coastal Wetlands to Rising Sea Level." *Ecology*, 83(10), 2869-2877.
- National Oceanic and Atmospheric Administration (NOAA). (2013a). "A Guide to National Shoreline Data and Terms: Glossary." *National Oceanic and Atmospheric Administration*, <<http://shoreline.noaa.gov/glossary.html#partj>> (Aug. 1, 2013).
- National Oceanic and Atmospheric Administration (NOAA). (2013b). "Sea Level Trends." *National Oceanic and Atmospheric Administration*, <<http://tidesandcurrents.noaa.gov/sltrends/seasonal.htm?stnid=8735180>> (Oct. 8, 2015).
- Roland, R. M. and Douglass, S. L. (2005). "Estimating Wave Tolerance of *Spartina Alterniflora* in Coastal Alabama." *Journal of Coastal Research*, 21(3), 453-463.
- Ruol, P. and Faedo, A. (2002). "Physical Model Study on Low-Crested Structures under Breaking Wave Conditions." *Proc., V MEDCOAST Workshops on Beaches of the Mediterranean and Black Sea, Turkey*, 83-96.
- Ruol, P., Faedo, A., and Paris, A. (2004). "Physical Model Study of Water Piling-up behind Low-crested Structures." *Coastal Engineering Conference, ASCE*, 29(4).
- Scyphers, S. B., Picou, S. J., and Powers, S. P. (2015). "Participatory Conservation of Coastal Habitats: The Importance of Understanding Homeowner Decision Making to Mitigate Cascading Shoreline Degradation." *Conservation Letters*, 8(1), 41-49.
- Scyphers, S. B., Powers, S. P., and Heck, K. J. (2014). "Ecological Value of Submerged Breakwaters for Habitat Enhancement on a Residential Scale." *Environmental Management*, 1-9.
- Scyphers, S. B., Powers, S. P., Heck, K. J., and Byron, D. (2011). "Oyster Reefs as natural Breakwaters Mitigate Shoreline Loss and Facilitate Fisheries." *PloS one*, 6(8).
- Shafer, D. J., Roland, R. M., and Douglass, S. L. (2003). "Preliminary Evaluation of Critical Wave Energy Thresholds at Natural and Created Coastal Wetlands." Engineering Research and Development Center, (No. ERDC-TN-WRP-HS-CP-2.2), Vicksburg, MS.
- Sorensen, R. M. (2006). *Basic Coastal Engineering*, 3rd Edition, Springer Science and Business Media, Inc., Bethlehem, PA.

- Stauble, D. K., Tabar, J. R., and Smith, J. B. (2000). "Performance of a Submerged Breakwater along a Hardbottom Influenced Coast: Vero Beach, Florida." *Proc., 13th National Conference on Beach Preservation Technology*, Florida Shore and Beach Preservation Association, Tallahassee, FL, 175-190.
- Stout, J. P. (1990). "Suggestions for Planting and Maintaining Wetlands in Coastal Alabama." *Alabama Department of Environmental Management*, Montgomery, AL, 1-47.
- Tait, R. J. (1972). "Wave Set-up on Coral Reefs." *Journal of Geophysical Research*, 77(12), 2207-2211.
- US Army Corps of Engineers (USACE). (1984). *Shore Protection Manual*. Army Engineer Waterways Experiment Station, Vicksburg, MS.

APPENDICES

APPENDIX: ADDITIONAL FIGURES

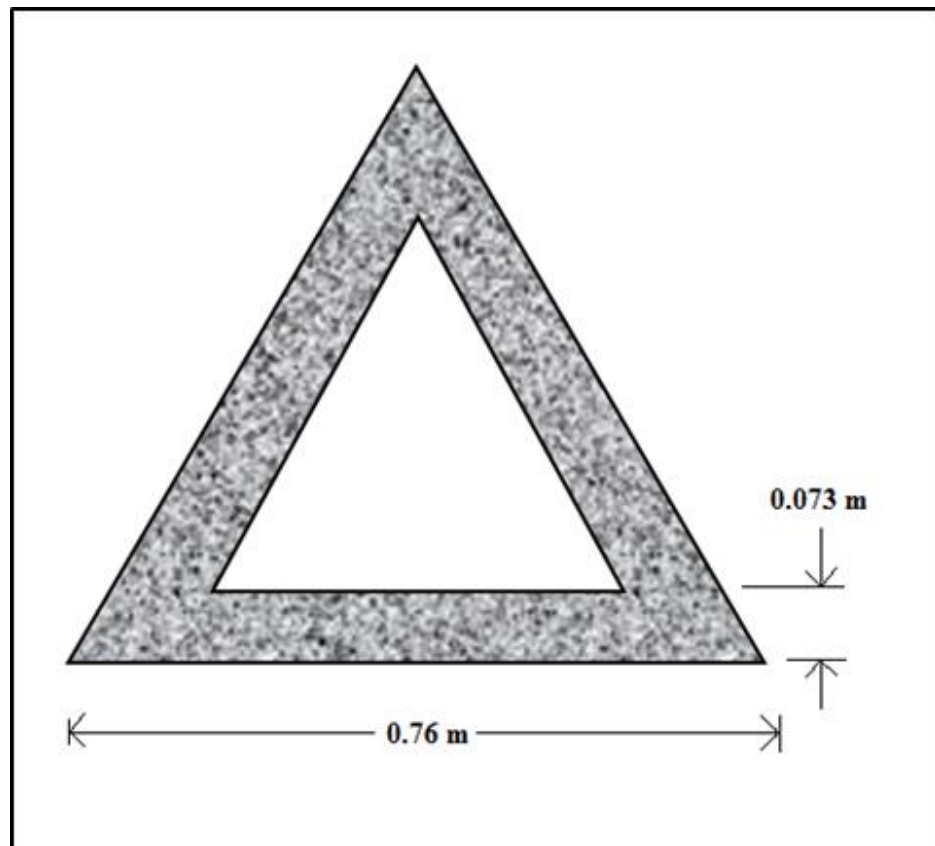

Figure A1. Plan View of a model ReefBLKSM unit with dimensions (Not drawn to scale) (Allen 2013).



Figure A2. Historical aerial imagery of the shoreline at Alabama Port, Alabama in May 2015 (Image © 2015 Digital Globe).



Figure A3. Erosional marsh shoreline (looking north) leeward of northern ReefBLKSM breakwater segment at Alabama Port, Alabama. Photo taken March 1, 2013.



Figure A4. Mounts developed to hold sensors at deployment locations. Designed by Bret Webb.

BIOGRAPHICAL SKETCH

BIOGRAPHICAL SKETCH

Name of Author: Kari P. Servold
Place of Birth: Colorado Springs, Colorado
Date of Birth: August 15, 1990

Graduate and Undergraduate Schools Attended:

The University of Alabama, Tuscaloosa, Alabama
University of South Alabama, Mobile, Alabama

Degrees Awarded:

Master of Science in Civil Engineering, 2015, Mobile, Alabama
Bachelor of Science in Geography, 2012, *cum laude*, Tuscaloosa, Alabama

Awards and Honors:

Graduate Research Assistant, Department of Civil Engineering, 2013
Graduate Research Assistant, Department of Civil Engineering, 2014
Graduate Research Assistant, Department of Civil Engineering, 2015
Tau Beta Pi Engineering Honor Society, 2014
David P. Simpson Coastal Engineering Scholarship, 2014